



# DirectCX CAMERA

---

Installation Manual

# Before reading this manual

This is a basic installation manual for use of an IDIS camera. Users who are using this product for the first time, as well as users with experience using comparable products, must read this operation manual carefully before use and need to the warnings and precautions contained herein while using the product. Safety warnings and precautions contained in this operation manual are intended to promote proper use of the product and thereby prevent accidents and property damage and must be followed at all times. Once you have read this operation manual, keep it at an easily accessible location for future reference.



- The manufacturer will not be held responsible for any product damage resulting from the use of unauthorized parts and accessories or from the user's failure to comply with the instructions contained in this manual.
- The information in this document is believed to be accurate as of the date of publication even though explanation about some functions may not be incorporated.  
The manufacturer is not responsible for any problems resulting from the use thereof.  
The information contained herein is subject to change without notice. Revisions or new editions to this publication may be issued to incorporate such changes.
- It is recommended that first-time users of this network camera and individuals who are not familiar with its use seek technical assistance from their retailer regarding product installation and use.
- If you need to disassemble the product for functionality expansion or repair purposes, you must contact your retailer and seek professional assistance.
- Both retailers and users should be aware that this product has been certified as being electromagnetically compatible for commercial use. If you have sold or purchased this product unintentionally, please replace with a consumer version.

# Safety Precautions

## WARNING

RISK OF ELECTRIC SHOCK  
DO NOT OPEN

**WARNING:** TO REDUCE THE RISK OF ELECTRIC SHOCK,  
DO NOT REMOVE COVER (OR BACK).  
NO USER-SERVICEABLE PARTS INSIDE.  
REFER SERVICING TO QUALIFIED SERVICE PERSONNEL.

### Important Safeguards

#### **1. Read Instructions**

All the safety and operating instructions should be read before the appliance is operated.

#### **2. Retain Instructions**

The safety and operating instructions should be retained for future reference.

#### **3. Cleaning**

Unplug this equipment from the wall outlet before cleaning it. Do not use liquid aerosol cleaners. Use a damp soft cloth for cleaning.

#### **4. Attachments**

Never add any attachments and/or equipment without the approval of the manufacturer as such additions may result in the risk of fire, electric shock or other personal injury.

#### **5. Water and/or Moisture**

Do not use this equipment near water or in contact with water.

#### **6. Placing and Accessories**

Do not place this equipment on an wall or ceiling that is not strong enough to sustain the camera. The equipment may fall, causing serious injury to a child or adult, and serious damage to the equipment. Wall or shelf mounting should follow the manufacturer's instructions, and should use a mounting kit approved by the Manufacturer.



This equipment and cart combination should be moved with care. Quick stops, excessive force, and uneven surfaces may cause the equipment and cart combination to overturn. Do not place this equipment in an enclosed space. Sufficient ventilation is required to prevent an increase in ambient temperature which can cause malfunction or the risk of fire.

#### **7. Power Sources**

This equipment should be operated only from the type of power source indicated on the marking label. If you are not sure of the type of power, please consult your equipment dealer or local power company.

You may want to install a UPS (Uninterruptible Power Supply) system for safe operation in order to prevent damage caused by an unexpected power stoppage. Any questions concerning UPS, consult your UPS retailer.

This equipment should be remain readily operable.

#### **8. Power Cord**

Operator or installer must remove power and TNT connections before handling the equipment.

#### **9. Lightning**

For added protection for this equipment during a lightning storm, or when it is left unattended and unused for long periods of time, unplug it from the wall outlet and disconnect the antenna or cable system. This will prevent damage to the equipment due to lightning and power-line surges. If thunder or lightning is common where the equipment is installed, use a surge protection device.

#### **10. Overloading**

Do not overload wall outlets and extension cords as this can result in the risk of fire or electric shock.

#### **11. Objects and Liquids**

Never push objects of any kind through openings of this equipment as they may touch dangerous voltage points or short out parts that could result in a fire or electric shock. Never spill liquid of any kind on the equipment.

#### **12. Servicing**

Do not attempt to service this equipment yourself. Refer all servicing to qualified service personnel.

#### **13. Damage requiring Service**

Unplug this equipment from the wall outlet and refer servicing to qualified service personnel under the following conditions:

- A. When the power-supply cord or the plug has been damaged.
- B. If liquid is spilled, or objects have hit the equipment.
- C. If the equipment has been exposed to rain or water.
- D. If the equipment does not operate normally by following the operating instructions, adjust only those controls that are covered by the operating instructions as an improper adjustment of other controls may result in damage and will often require extensive work by a qualified technician to restore the equipment to its normal operation.
- E. If the equipment has been dropped, or the cabinet damaged.
- F. When the equipment exhibits a distinct change in performance — this indicates a need for service.

#### **14. Replacement Parts**

When replacement parts are required, be sure the service technician has used replacement parts specified by the manufacturer or that have the same characteristics as the original part. Unauthorized substitutions may result in fire, electric shock or other hazards.

#### **15. Safety Check**

Upon completion of any service or repairs to this equipment, ask the service technician to perform safety checks to determine that the equipment is in proper operating condition.

#### **16. Field Installation**

This installation should be made by a qualified service person and should conform to all local codes.

#### **17. Correct Batteries**

Warning: Risk of explosion if battery is replaced by an incorrect type. Replace only with the same or equivalent type.

Dispose of used batteries according to the instructions.

The battery shall not be exposed to excessive heat such as sunshine, fire or the like.

#### **18. Tmra**

A manufacturer's maximum recommended ambient temperature (Tmra) for the equipment must be specified so that the customer and installer may determine a suitable maximum operating environment for the equipment.

## FCC Compliance Statement

THIS EQUIPMENT HAS BEEN TESTED AND FOUND TO COMPLY WITH THE LIMITS FOR A CLASS A DIGITAL DEVICE, PURSUANT TO PART 15 OF THE FCC RULES. THESE LIMITS ARE DESIGNED TO PROVIDE REASONABLE PROTECTION AGAINST HARMFUL INTERFERENCE WHEN THE EQUIPMENT IS OPERATED IN A COMMERCIAL ENVIRONMENT. THIS EQUIPMENT GENERATES, USES, AND CAN RADIATE RADIO FREQUENCY ENERGY AND IF NOT INSTALLED AND USED IN ACCORDANCE WITH THE INSTRUCTION MANUAL, MAY CAUSE HARMFUL INTERFERENCE TO RADIO COMMUNICATIONS. OPERATION OF THIS EQUIPMENT IN A RESIDENTIAL AREA IS LIKELY TO CAUSE HARMFUL INTERFERENCE, IN WHICH CASE USERS WILL BE REQUIRED TO CORRECT THE INTERFERENCE AT THEIR OWN EXPENSE.

**WARNING:** CHANGES OR MODIFICATIONS NOT EXPRESSLY APPROVED BY THE PARTY RESPONSIBLE FOR COMPLIANCE COULD VOID THE USER'S AUTHORITY TO OPERATE THE EQUIPMENT. THIS CLASS OF DIGITAL APPARATUS MEETS ALL REQUIREMENTS OF THE CANADIAN INTERFERENCE CAUSING EQUIPMENT REGULATIONS.

## EU Conformity Statement

This product and - if applicable - the supplied accessories too are marked with "CE" and comply therefore with the applicable harmonized European standards listed under the Low Voltage Directive 2006/95/EC, the EMC Directive 2004/108/EC.

## WEEE (Waste Electrical & Electronic Equipment)

### Correct Disposal of This Product

**(Applicable in the European Union and other European countries with separate collection systems)**



This marking shown on the product or its literature, indicates that it should not be disposed with other household wastes at the end of its working life. To prevent possible harm to the environment or human health from uncontrolled waste disposal, please separate this from other types of wastes and recycle it responsibly to promote the sustainable reuse of material resources.

Household users should contact either the retailer where they purchased this product, or their local government office, for details of where and how they can take this item for environmentally safe recycling. Business users should contact their supplier and check the terms and conditions of the purchase contract. This product should not be mixed with other commercial wastes for disposal.

## Copyright

© 2016 IDIS Co., Ltd.

IDIS Co., Ltd. reserves all rights concerning this operation manual.

Use or duplication of this operation manual in part or whole without the prior consent of IDIS Co., Ltd. is strictly prohibited.

Contents of this operation manual are subject to change without prior notice for reasons such as functionality enhancements.

## Registered Trademarks

IDIS is a registered trademark of IDIS Co., Ltd.

Other company and product names are registered trademarks of their respective owners.

This product contains software built partially on open-source content. Codes for the corresponding open-source content are available for download. For more information, refer to the software CD (OpenSourceGuide\OpenSourceGuide.pdf) or the open source guide accompanying this operation manual.

# Accessories

Upon purchasing the product, check inside the box to make sure all the following accessories are included. External appearances and colors of the accessories may vary depending on the model.



CAMERA

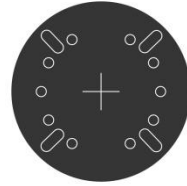

DRILL TEMPLATE

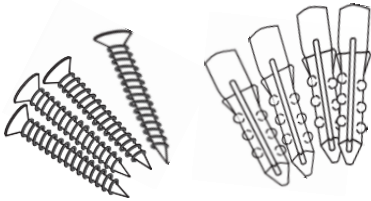

SCREW 4EA, ANCHOR 4EA

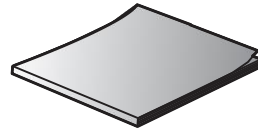

QUICK GUIDE

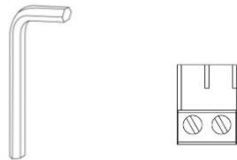

ALLEN WRENCH 1EA, TERMINAL BLOCK(1EA. DC12V/AC24V)



DESICCANT

## CABLE

### DUAL(DC12V/AC24V)

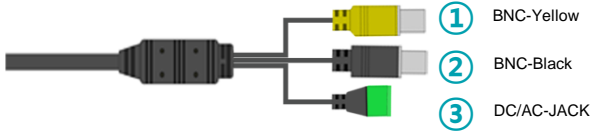

①	BNC (CVBS VIDEO OUT)
②	BNC (HD-TVI VIDEO OUT)
③	DC12V / AC24V

### POC

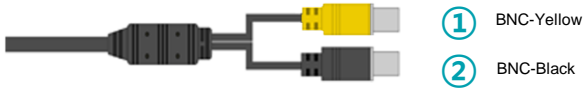

①	BNC (CVBS VIDEO OUT)
②	BNC (HD-TVI VIDEO OUT)

## DIMENSION

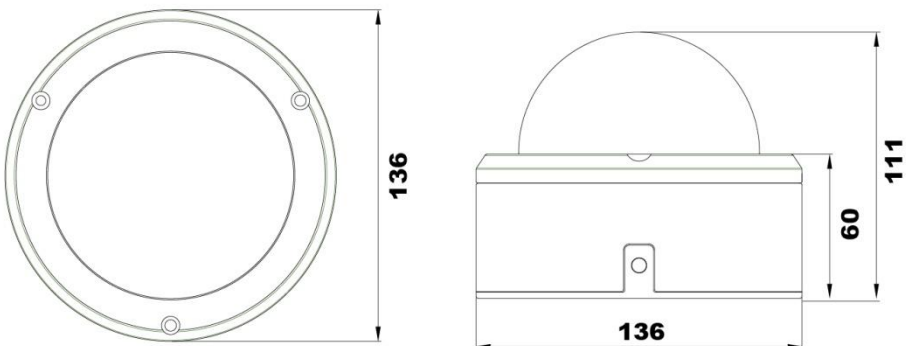

## Camera Setting Menu - 1

MENU	Details-1	Details-2	Details-3
<b>IRIS</b>	ELC		
<b>EXPOSURE</b>	BRIGHTNESS	0 ~ 20	
	SHUTTER	AUTO	DEBLUR/NORMAL
		MANUAL	1/30, 1/60, 1/120 , 1/240, 1/480, 1/1000, 1/2000, 1/4000, 1/8000, 1/15000, 1/30000
		FLICKER	
	SENS_UP	OFF, X2 ~ X32	
AGC	0 ~ 10		
<b>BACKLIGHT</b>	OFF		
	HLC	MODE	NIGHT ONLY , ALL DAY
		LEVEL	0 ~ 20
		COLOR	BLK,COSTOMIZE,WHT,YEL,CYN,GRN, MAG,RED,BLU
	BLC	H-POS	0 ~ 20
		V-POS	0 ~ 20
		H-SIZE	0 ~ 20
		V-SIZE	0 ~ 20
	WDR	MODE	NORMAL/ROI
		WEIGHT	LOW/MIDDLE/HIGH
<b>DAY &amp; NIGHT</b>	COLOR		
	B & W	SMART IR	ON/OFF
		ANTI-SAT.	0 ~ 20
	EXTERN	SMART IR	ON/OFF
		ANTI-SAT.	0 ~ 20
		EXTERN S/W	LOW/HIGH
		DELAY	LOW/MIDDLE/HIGH
	<b>COLOR</b>	AWB	AUTO/AUTOext/PRESET/MANUAL
COLOR GAIN		0 ~ 20	
<b>DNR</b>	OFF/LOW/MIDDLE/HIGH		

## Camera Setting Menu - 2

MENU	Details-1	Details-2	Details-3
IMAGE	SHARPNESS	TVI	0 ~ 10
		AHD	0 ~ 10
	GAMMA	0.45/0.55/0.65/0.75	
	MIRROR	ON/OFF	
	FLIP	ON/OFF	
	DEFOG	OFF	
		ON MODE	MANUAL/AUTO
		ON LEVEL	LOW/MIDDLE/HIGH
	PRIVACY OFF		
	PRIVACY ON	ZONE NUM	0 ~ 15
		ZONE DISP	ON/OFF
		H-POS	0 ~ 60
		V-POS	0 ~ 34
		H-SIZE	0 ~ 60
V-SIZE		0 ~ 34	
Y LEVEL		0 ~ 20	
CB LEVEL		0 ~ 20	
CR LEVEL		0 ~ 20	
TRANS		0 ~ 3	
MOTION	OFF		
	ON	DET WINDOW	WINDOW ZONE 0 ~ 3
			WINDOW USE ON/OFF
			DET H-POS 0 ~ 60
			DET V-POS 0 ~ 34
			DET H-SIZE 0 ~ 60
			DET V-SIZE 0 ~ 34
	DET TONE	0 ~ 4	
	MDIRECT FILL	ON/OFF	
	SENSITIVITY	0 ~ 10	
	MOTION OSD	ON/OFF	
TEXT ALARM	ON/OFF		
OUTPUT MODE	OUTPUT	TVI/AHD/CVBS	
	FRAME RATE	1080 30P	
	FREQ	50Hz/60Hz	



## Camera Setting Menu - 3

MENU	Details-1	Details-2	Details-3
SYSTEM	IMAGE RANGE	FULL/COMP/USER	
	COLOR SPACE	HD_CbCr/YUV/SD_CbCr	
	COLOR BAR	ON/OFF	
	LANGUAGE	ENG/KOR/JPN/CHN(S)/CHN	
	CAM TITLE	OFF/LEFT DOWN/RIGHT UP	
	RESET	ON	
EXIT	SAVE/CANCEL		

## Specifications

<b>Camera</b>	
Image Sensor	1/2.8 Inch SONY CMOS
Resolution	1080P Full HD
Max. Resolution	1984(H) x 1097 (V)
TV System	PAL / NTSC
Electronic Shutter	Auto, 1/30~1/30,000
S/N Ratio	More than 50dB
<b>Lens</b>	
Focus Length	2.8~12mm
Pixels	2M Pixel
<b>Night Vision</b>	
Infrared LED	24 IR LED
<b>Infrared Distance</b>	15M
<b>Function</b>	
Day/Night	Color/B&W/EXTERN
White Balance	AUTO, MANUAL, PRESET, AUTOext
Gain Control	Level Setting(0~20)
Noise Reduction	OFF/LOW/MIDDLE/HIGH
WDR	OFF/LOW/MIDDLE/HIGH
OSD Support	YES
UTC	YES
<b>Operating Environment</b>	
Housing	Metal(IP66)
Operating Temperature	-10°C ~ +55°C / 32°F ~ 131°F, 30% ~ 80% RH
Storage Temperature	-20°C ~ +60°C RH95% Max
<b>Power &amp; Exterior</b>	
Power Consumption	DUAL / 6W   POC / 9W
Dimension	∅ 136 x 111(H) mm

## Trouble Shooting

Problem	Check
The main unit won't turn on.	<ul style="list-style-type: none"> <li>• Check the power cable connection.</li> <li>• Check the power outlet.</li> </ul>
No Picture after providing power	<ul style="list-style-type: none"> <li>• May be the power supply voltage abnormality, please check the power supply voltage and pole whether exactitude. Please check all the connecting cable and monitors whether be connected correctly or not.</li> </ul>
I can't see Live videos.	<ul style="list-style-type: none"> <li>• Check the camera's power status.</li> <li>• Check the network connection status of the computer and the network camera.</li> </ul>
Images are blurry.	<ul style="list-style-type: none"> <li>• Make sure the lens is clean. If not, clean it using a soft piece of cloth or a brush.</li> <li>• Make sure the lens is in focus. Adjust the focus during daytime.</li> <li>• If there is too much light coming into the camera or the camera is picking up an overly bright light source, adjust the camera's position/angle accordingly.</li> </ul>
Video color appears incorrect.	<p>Check the white balance settings. If using the Auto option, it may take some time for the white balance to be adjusted.</p>
Images are blinking.	<p>If the camera is pointed at the sun or a fluorescent lamp, adjust the camera's angle away.</p>
The picture background color changes continuously	<p>The fluorescent lamp's electromagnetic field cause color roll. This is proper phenomenon of the cameras. Reduce the fluorescent lamp numbers or increase the distance between the camera and the fluorescent lamps can improve it. Use power supply external sync. camera can solve it.</p>
The picture level direction have flowing interference ripples	<p>May be caused by the power supply AC ripples, it need filter the wave of the power supply. Check the monitor and peripheral equipment used.</p>



**IDIS Co., Ltd.**

For more information, please visit at  
[www.idisglobal.com](http://www.idisglobal.com)