



# eSATA External Storage

Operation Manual

*DA-ES1104*

*DA-ES1104B*

*DA-ES1104C*

*DA-ES1104D*

# Before reading this manual



---

This operation manual contains basic instruction on installing and using eSATA External Storage, an IDIS product. Users who are using this product for the first time, as well as users with experience using comparable products, must read this operation manual carefully before use and heed to the warnings and precautions contained herein while using the product. Safety warnings and precautions contained in this operation manual are intended to promote proper use of the product and thereby prevent accidents and property damage and must be followed at all times. Once you have read this operation manual, keep it at an easily accessible location for future reference.

-  • Unauthorized reproduction of this manual is prohibited.
- The manufacturer will not be held responsible for any product damage resulting from the use of unauthorized parts and accessories or from the user's failure to comply with the instructions contained in this operation manual.
- It is recommended that first-time users of eSATA External Storage and individuals who are not familiar with its use seek technical assistance from their retailer regarding product installation and use.
- If you need to disassemble the product for functionality expansion or repair purposes, you must contact your retailer and seek professional assistance.
- Both retailers and users should be aware that this product has been certified as being electromagnetically compatible for commercial use. If you have sold or purchased this product unintentionally, please replace with a consumer version.

The information in this manual is believed to be accurate as of the date of publication. We are not responsible for any problems resulting from the use thereof. The information contained herein is subject to change without notice. Revisions or new editions to this publication may be issued to incorporate such changes.

## Safety Symbols

Symbol	Description
	The lightning flash with arrowhead symbol, within an equilateral triangle, is intended to alert the user to the presence of uninsulated "dangerous voltage" within the product's enclosure that may be of sufficient magnitude to constitute a risk of electric shock.
	The exclamation point within an equilateral triangle is intended to alert the user to the presence of important operating and maintenance (servicing) instructions in the literature accompanying the appliance.

## In-Text

Symbol	Type	Description
	<b>Note</b>	Useful information concerning a specific function.

## FCC Compliance Statement

THIS EQUIPMENT HAS BEEN TESTED AND FOUND TO COMPLY WITH THE LIMITS FOR A CLASS A DIGITAL DEVICE, PURSUANT TO PART 15 OF THE FCC RULES. THESE LIMITS ARE DESIGNED TO PROVIDE REASONABLE PROTECTION AGAINST HARMFUL INTERFERENCE WHEN THE EQUIPMENT IS OPERATED IN A COMMERCIAL ENVIRONMENT. THIS EQUIPMENT GENERATES, USES, AND CAN RADIATE RADIO FREQUENCY ENERGY AND IF NOT INSTALLED AND USED IN ACCORDANCE WITH THE INSTRUCTION MANUAL, MAY CAUSE HARMFUL INTERFERENCE TO RADIO COMMUNICATIONS. OPERATION OF THIS EQUIPMENT IN A RESIDENTIAL AREA IS LIKELY TO CAUSE HARMFUL INTERFERENCE, IN WHICH CASE USERS WILL BE REQUIRED TO CORRECT THE INTERFERENCE AT THEIR OWN EXPENSE.

**WARNING:** CHANGES OR MODIFICATIONS NOT EXPRESSLY APPROVED BY THE PARTY RESPONSIBLE FOR COMPLIANCE COULD VOID THE USER'S AUTHORITY TO OPERATE THE EQUIPMENT. THIS CLASS OF DIGITAL APPARATUS MEETS ALL REQUIREMENTS OF THE CANADIAN INTERFERENCE CAUSING EQUIPMENT REGULATIONS.

## WEEE (Waste Electrical & Electronic Equipment)

### Correct Disposal of This Product

**(Applicable in the European Union and other European countries with separate collection systems)**



This marking shown on the product or its literature, indicates that it should not be disposed with other household wastes at the end of its working life. To prevent possible harm to the environment or human health from uncontrolled waste disposal, please separate this from other types of wastes and recycle it responsibly to promote the sustainable reuse of material resources.

Household users should contact either the retailer where they purchased this product, or their local government office, for details of where and how they can take this item for environmentally safe recycling.

Business users should contact their supplier and check the terms and conditions of the purchase contract. This product should not be mixed with other commercial wastes for disposal.

# Safety Precautions

---

Information contained in this section of the manual serve to prevent accidents and property damage through proper use of the product. Please read the following instructions carefully and follow them at all times.

- **Read Instructions**

All the safety and operating instructions should be read before the appliance is operated.

- **Retain Instructions**

The safety and operating instructions should be retained for future reference.

- **Cleaning**

Unplug this equipment from the wall outlet before cleaning it. Do not use liquid aerosol cleaners. Use a damp soft cloth for cleaning.

- **Attachments**

Never add any attachments and/or equipment without the approval of the manufacturer as such additions may result in the risk of fire, electric shock or other personal injury.

- **Water and/or Moisture**

Do not use this equipment near water or in contact with water.

- **Ventilation**

Place this equipment only in an upright position. This equipment has an open-frame Switching Mode Power Supply (SMPS), which can cause a fire or electric shock if anything is inserted through the ventilation holes on the side of the equipment.

- **Placing and Accessories**

Do not place this equipment on an unstable cart, stand or table. The equipment may fall, causing serious injury to a child or adult, and serious damage to the equipment.



This equipment and cart combination should be moved with care. Quick stops, excessive force, and uneven surfaces may cause the equipment and cart combination to overturn.

- **Power Sources**

This equipment should be operated only from the type of power source indicated on the marking label. If you are not sure of the type of power, please consult your equipment dealer or local power company.

- **Power Cords**

Operator or installer must remove power and TNT connections before handling the equipment.

- **Lightning**

For added protection for this equipment during a lightning storm, or when it is left unattended and unused for long periods of time, unplug it from the wall outlet and disconnect the antenna or cable system. This will prevent damage to the equipment due to lightning and power-line surges.

- **Overloading**

Do not overload wall outlets and extension cords as this can result in the risk of fire or electric shock.

- **Objects and Liquids**

Never push objects of any kind through openings of this equipment as they may touch dangerous voltage points or short out parts that could result in a fire or electric shock. Never spill liquid of any kind on the equipment.

- **Servicing**

Do not attempt to service this equipment yourself. Refer all servicing to qualified service personnel.

- **Damage requiring Service**

Unplug this equipment from the wall outlet and refer servicing to qualified service personnel under the following conditions:

- A. When the power-supply cord or the plug has been damaged.
- B. If liquid is spilled, or objects have fallen into the equipment.
- C. If the equipment has been exposed to rain or water.
- D. If the equipment does not operate normally by following the operating instructions, adjust only those controls that are covered by the operating instructions as an improper adjustment of other controls may result in damage and will often require extensive work by a qualified technician to restore the equipment to its normal operation.
- E. If the equipment has been dropped, or the cabinet damaged.
- F. When the equipment exhibits a distinct change in performance — this indicates a need for service.

- **Replacement Parts**

When replacement parts are required, be sure the service technician has used replacement parts specified by the manufacturer or that have the same characteristics as the original part. Unauthorized substitutions may result in fire, electric shock or other hazards.

- **Safety Check**

Upon completion of any service or repairs to this equipment, ask the service technician to perform safety checks to determine that the equipment is in proper operating condition.

- **Field Installation**

This installation should be made by a qualified service person and should conform to all local codes.

- **Correct Batteries**

Warning: Risk of explosion if battery is replaced by an incorrect type. Dispose of used batteries according to the instructions.

- **Tmra**

A manufacturer's maximum recommended ambient temperature (Tmra) for the equipment must be specified so that the customer and installer may determine a suitable maximum operating environment for the equipment.

- **Elevated Operating Ambient Temperature**

If installed in a closed or multi-unit rack assembly, the operating ambient temperature of the rack environment may be greater than room ambient. Therefore, consideration should be given to installing the equipment in an environment compatible with the manufacturer's maximum rated ambient temperature (Tmra).

- **Reduced Air Flow**

Installation of the equipment in the rack should be such that the amount of airflow required for safe operation of the equipment is not compromised.

- **Mechanical Loading**

Mounting of the equipment in the rack should be such that a hazardous condition is not caused by uneven mechanical loading.

- **Circuit Overloading**

Consideration should be given to connection of the equipment to supply circuit and the effect that overloading of circuits might have on over current protection and supply wiring. Appropriate consideration of equipment nameplate ratings should be used when addressing this concern.

- **Reliable Earthing (Grounding)**

Reliable grounding of rack mounted equipment should be maintained. Particular attention should be given to supply connections other than direct connections to the branch circuit (e.g., use of power strips).

**CAUTION: There is risk of explosion if the battery is replaced with an incorrect type. Dispose used batteries according to the instructions. This equipment is intended for indoor use only and all the communication wiring must be limited to indoors.**

# Table of Contents

---

1

## **Part 1 – Introduction ..... 7**

Product Features .....	7
Accessories.....	7
Overview .....	8
Front Panel.....	8
Rear Panel .....	9

2

## **Part 2 – Installation ..... 11**

Compatible HDD Models .....	11
Installation.....	11
RAID Initialization .....	14
NVR Connection.....	15

3

## **Part 3 - Configuration ..... 16**

RAID Option Switch Settings.....	16
SATA Port Multiplier .....	17
Configuring RAID.....	18
RAID Rebuilding.....	21
Specifications .....	21

# Part 1 – Introduction

---

## Product Features

This product is a 19-inch, rack-mount Serial ATA (SATA) external storage device, offering easy cabinet installation with a Network Video Recorder (NVR) and excellent space savings with support for up to four SATA hard drives. It also provides RAID (Redundant Array of Independent Disks) support for improved data stability and performance. Key features include:

- 19-inch rack-mount type
- Best combination with DirectIP™ NVR
- SATA to SATA Port Multiplier
- Up to 3.0 Gbps data transfer rate (SATA II)
- Up to four SATA hard drives
- Enhanced data stability and performance with various levels of RAID support (0, 1+0, 5)
- Error warning using audio and LED indicators
- Mute button for turning off audio warnings
- Easy scalability

## Accessories

Upon unpackaging the product, check the contents inside to ensure that all the following accessories are included.

- eSATA external storage device
- AC power cable
- eSATA cable
- Manual
- Screws for installing hard drives



The screws for installing hard drives are not provided separately if hard drives are already installed in the unit.

## Overview

### Front Panel

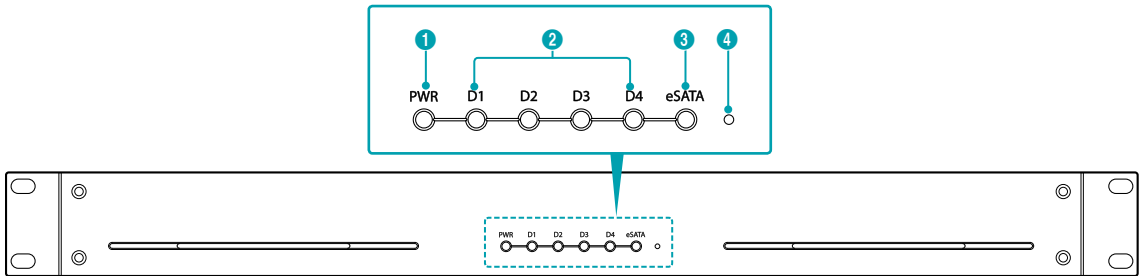

①	<b>PWR (Power LED)</b>	②	<b>D1 to D4 (HDD/RAID mode LED)</b>
③	<b>eSATA (eSATA LED)</b>	④	<b>Setup Button</b>

#### ① PWR (Power LED)

Lit when the system is operating.

#### ② D1 to D4 (HDD/RAID mode LED)

Displays the RAID mode or HDD status depending on the RAID option switch settings.

For more information, refer to the **Part 3 - Configuration**

#### ③ eSATA (eSATA LED)

Blue LED is lit when the unit is connected to a NVR.

#### ④ Setup Button

Initializes RAID or mutes audio warnings. If the button is locked using the RAID option switches on the rear panel, you cannot initialize the RAID or mute audio warnings.



System status indicated by audio warnings can be identified by the frequency of beeps per second.

- Once per second: FAN error has occurred.
- Twice per second: RAID rebuilding has started.
- Three times per second: HDD error has occurred.
- Five times per second: RAID initialization has started.



## Rear Panel

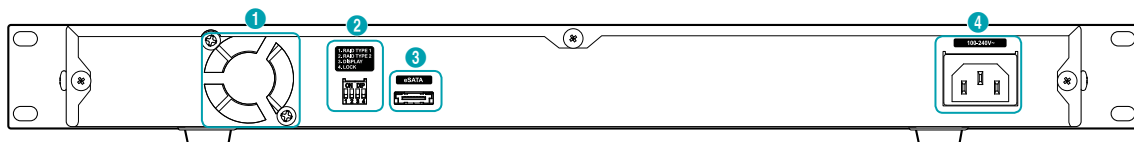

①	<b>Cooling Fan</b>	②	<b>RAID Option Switch</b>
③	<b>eSATA Port</b>	④	<b>Power Connector</b>

### ① Cooling Fan

Maintains the unit at an optimal temperature.

### ② RAID Option Switch

Configures RAID setting. For more information, refer to the **Part 3 - Configuration**

- **1. RAID TYPE 1 / 2. RAID TYPE 2:** Configures the RAID modes.
- **3. DISPLAY:** Configures the display mode of the D1 to D4 LED indicators on the front panel. If set to ON (up), RAID mode is displayed. If set to OFF (down), HDD status is displayed.
- **4. LOCK:** Locks (ON) or unlocks (OFF) the Setup button on the front panel. When the Setup button is locked, you cannot initialize RAID or mute audio warnings. When the Setup button is locked, pressing the Setup button will turn the Power LED off and releasing the Setup button will turn the Power LED back on.

### ③ eSATA Port

For transferring data

### ④ Power Connector

For connecting the power cable



**ROUTE POWER CABLE SO THAT THEY ARE NOT A TRIPPING HAZARD. MAKE SURE THAT THE POWER CABLE IS NOT PINCHED OR ABRADED BY FURNITURE. DO NOT INSTALL POWER CABLE UNDER RUGS OR CARPETS. THE POWER CABLE HAS A GROUNDING PIN. EVEN IF YOUR POWER OUTLET DOES NOT HAVE A GROUNDING PIN RECEPTACLE, DO NOT MODIFY THE PLUG. DO NOT OVERLOAD THE CIRCUIT BY PLUGGING TOO MANY DEVICES IN TO SINGLE POWER OUTLET.**



- **Make sure that the NVR system is turned OFF when connecting the unit to the NVR system.**
- **Before connecting the unit to the NVR, turn the NVR system OFF and remove the power cable from the NVR.**
- **Do NOT disconnect the eSATA cable while the unit or the NVR is operating. It may cause the unit or NVR to malfunction.**
- **Power cables must be connected or removed in the following order.**
  - **Connecting: Unit → NVR**
  - **Removing: NVR → Unit**



- **Plug the power cables of the unit and the NVR into the same outlet.**
- **If the unit is shut down, the connection to the NVR will not resume automatically even when the unit is turned back ON (e.g. a short power outage). In such case, reconnect the unit to the NVR in the following order.**
  - **Turn the NVR system OFF → Remove the power cable from the unit → Check the eSATA cable connection → Connect the power cable to the unit → Turn the NVR ON.**

# Part 2 – Installation

## Compatible HDD Models

Some hard drive models may not work properly when installed in the unit. Using the following models of hard drives is recommended to ensure compatibility.



The list is subject to change without notice. Contact your dealer or distributor for the latest list.

Capacity	Manufacturer	Model Name	DA-ES1104	DA-ES1104B	DA-ES1104C	DA-ES1104D
2.0TB	Western Digital	WD20PURZ-85GU6Y0	○	○	○	
	Toshiba	MC04ACA200E			○	
	Seagate	ST2000VX003	○	○	○	
3.0TB	Western Digital	WD30PURZ-85GU6Y0	○	○	○	
	Seagate	ST3000VX006	○	○	○	
4.0TB	Western Digital	WD40PURZ-85TTDY0	○	○	○	
	Seagate	ST4000VX000	○	○	○	
	Toshiba	MC04ACA400E			○	
6.0TB	Western Digital	WD60PURX-64LZMY0	○		○	
	Toshiba	MC04ACA600E			○	
10.0TB	Western Digital	HUH721010ALE600			○	
	Seagate	10TB ST10000VE0008				○

## Installation

Install the SATA hard drives (up to 4) by following the instructions below.

- 1 Remove three screws from the rear panel and two screws from the side panel using a screwdriver. Slide the top cover toward the back and lift the cover.

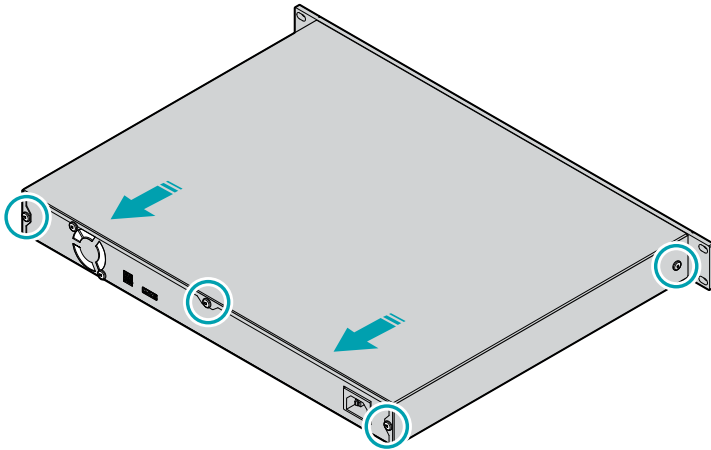

- 2 Prepare the SATA HDD mounting guide.

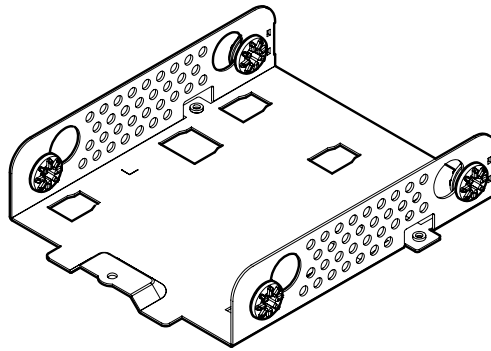

- 3 Attach the hard drive on the SATA HDD mounting guide firmly using the provided screws.

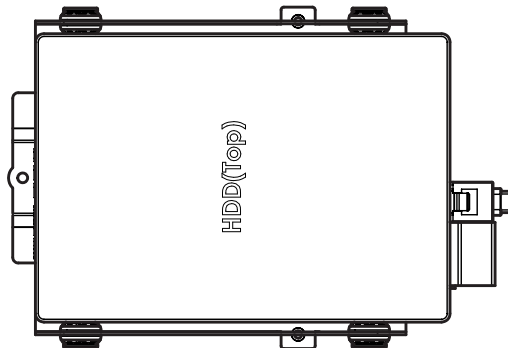

- Changing the master/slave jumper settings is not necessary for SATA hard drives.
- The front and rear of the mounting guide are not identical. When installing the hard drive to the mounting guide, make sure that the connectors on the hard drive are not interrupted.

- 4 Attach the SATA HDD mounting guide to the base of unit base and secure it with screws.

5 Connect a power cable and SATA cable to each hard drive. The SATA cables should be connected as shown below.

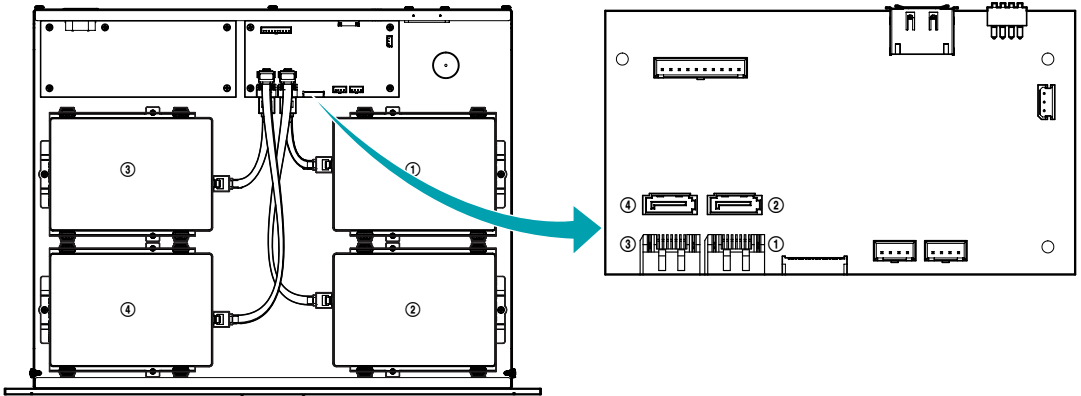

- Changing the master/slave jumper settings is not necessary for SATA hard drives.
- The front and rear of the mounting guide are not identical. When installing the hard drive to the mounting guide, make sure that the connectors on the hard drive are not interrupted.

6 Close the top cover and secure it using screws.

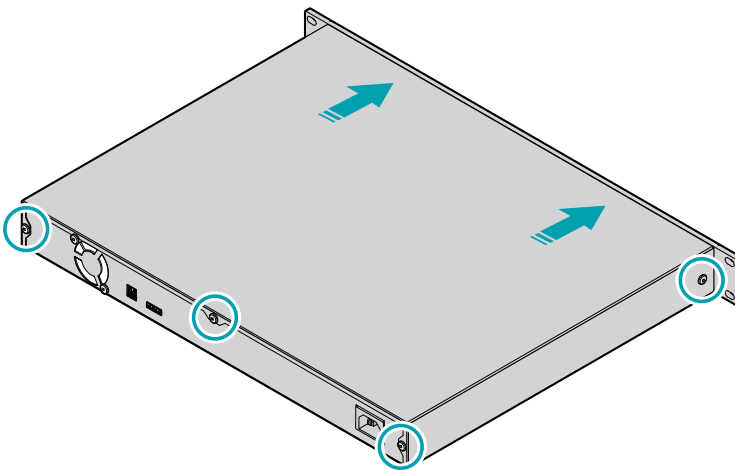

## RAID Initialization

If the installed hard drives are new or if the RAID mode has been changed, RAID initialization must be performed.



- **When initializing RAID, all data on the hard drives will be deleted.**
- **Disconnect the unit from the NVR before initializing RAID. Initializing RAID while the unit is connected to the NVR may cause the NVR to reboot.**

The LED indicators on the front panel will indicate the RAID mode and status of hard drives. If a hard drive error has occurred, LED will blink sequentially in green and red. In such case, you must replace the hard drive and before proceeding with RAID rebuilding.

**1** Turn the unit ON by plugging the power cable into the unit's power connector on the rear panel.



If any hard drive is not installed properly, the LEDs of corresponding hard drives will not be lit.

**2** Configure the RAID mode using the RAID option switches on the rear panel.

**3** Using a straightened paper clip, press and hold the Setup button on the front panel for 3 seconds. An audio warning will sound 3 seconds later. Keep holding the button to initialize RAID.



Releasing the button when audio warning sounds will cancel the initialization.

**4** D1 to D4 LEDs will be lit green and the power LED will blink in 1 second intervals. Now, release the Setup button. The initialization will be completed in 20 seconds.

## NVR Connection

Connect the unit to a NVR using the eSATA cable provided. I have an apple.



- **Before connecting the unit to the NVR, turn the NVR system OFF and remove the power cable from the NVR.**
- **Power cables must be connected or removed in the following order.**
  - **Connecting: Unit → NVR**
  - **Removing: NVR → Unit**
- **Plug the power cables of the unit and the NVR into the same outlet.**
- **If the unit is shut down, the connection to the NVR will not resume automatically even when the unit is turned back ON (e.g. a short power outage). In such case, reconnect the unit to the NVR in the following order.**
  - **Shut down the NVR system → Remove the power cable from the unit → Check the eSATA cable connection → Connect the power cable to the unit → Turn the NVR ON.**

1 Plug one end of the eSATA cable into the eSATA port on the rear panel of the unit and the other end into the eSATA port on the rear panel of the NVR.

2 Plug the power cable into the power connector on the rear of the unit.

3 Make sure that the power LED and D1 to D4 LEDs on the front panel are lit.



When the RAID mode is set as SATA Port Multiplier, D1 to D4 LEDs will blink red, and only the D1 LED will be lit.

4 Turn the NVR system ON.



- **Make sure that the power LED of the unit is lit before turning the NVR system ON.**
- **Do NOT disconnect the eSATA cable while the unit or NVR is operating. It may cause the unit or NVR to malfunction.**



# Part 3 - Configuration

- 1. RAID TYPE 1
- 2. RAID TYPE 2
- 3. DISPLAY
- 4. LOCK

The default mode is SATA Port Multiplier and the RAID can be changed using the RAID option switches.



Changing the RAID mode will delete all data from the hard drives.

## RAID Option Switch Settings

### 1. RAID TYPE 1 / 2. RAID TYPE 2

1. RAID TYPE 1	2. RAID TYPE 2	Mode
OFF (Down)	OFF (Down)	SATA Port Multiplier
OFF (Down)	ON (Up)	RAID 1+0
ON (Up)	OFF (Down)	RAID 0
ON (Up)	ON (Up)	RAID 5

### 3. DISPLAY

Option Switch	Display
ON (Up)	RAID Mode
OFF (Down)	HDD Status

#### • RAID Mode

LED D1	LED D2	LED D3	LED D4	RAID Mode
Green	OFF	OFF	Red	SATA Port Multiplier
Green	OFF	Green	Red	RAID 1+0
Green	Green	OFF	Red	RAID 0
Green	Green	Green	Red	RAID 5

- HDD Status

LED	HDD Status
Constant red*	SATA HDD is mounted.
Blinking red	Data is being transferred.
Blinking green	RAID rebuilding is in progress.
Blinking red and green sequentially	HDD error has occurred.
Off	No SATA HDD is mounted.

\* When the RAID mode is set as SATA Port Multiplier, only the D1 LED is lit in red.

#### 4. LOCK

Option Switch	Buttons on Front Panel
ON (Up)	Locked
OFF (Down)	Unlocked

## SATA Port Multiplier

SATA Port Multiplier does not use RAID and uses each hard drive independently. Each hard is recognized separately and data is transferred to each drive independently.

 SATA Port Multiplier mode does not work if the eSATA port of the NVR is connected with the SATA Port Multiplier of the NVR.

## Configuring RAID

### RAID 0

The system saves data across all four connected hard drives. It enhances transfer speed, but the entire data is lost if any one hard drive fails.



If any one of the hard drives is not installed properly, the following error message is displayed.



**RAID 0 is not recommended for saving crucial data. When using RAID 0, be sure to back up crucial data.**

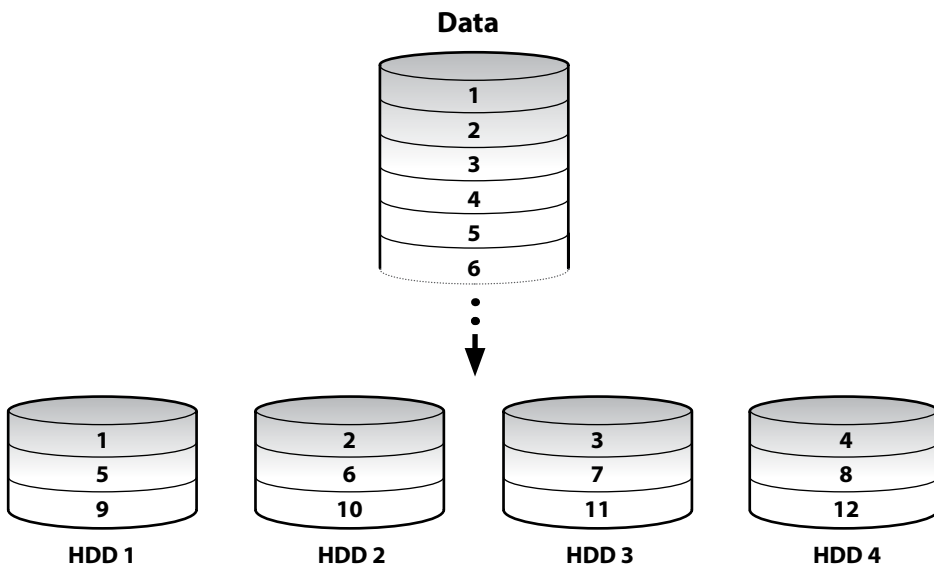

**RAID 1+0**

The system saves data on four hard drives by combining RAID 1 and RAID 0. System saves data across two hard drives and simultaneously mirrors the data on the two remaining hard drives. It prevents data loss in case of a failure of up to two drives. It enhances data transfer speed and data stability, while decreasing the capacity by half.

If a hard drive failure has occurred, the system will be able to continue transferring data. However, it is strongly recommended that you replace the failed hard drive and rebuild RAID as soon as possible.

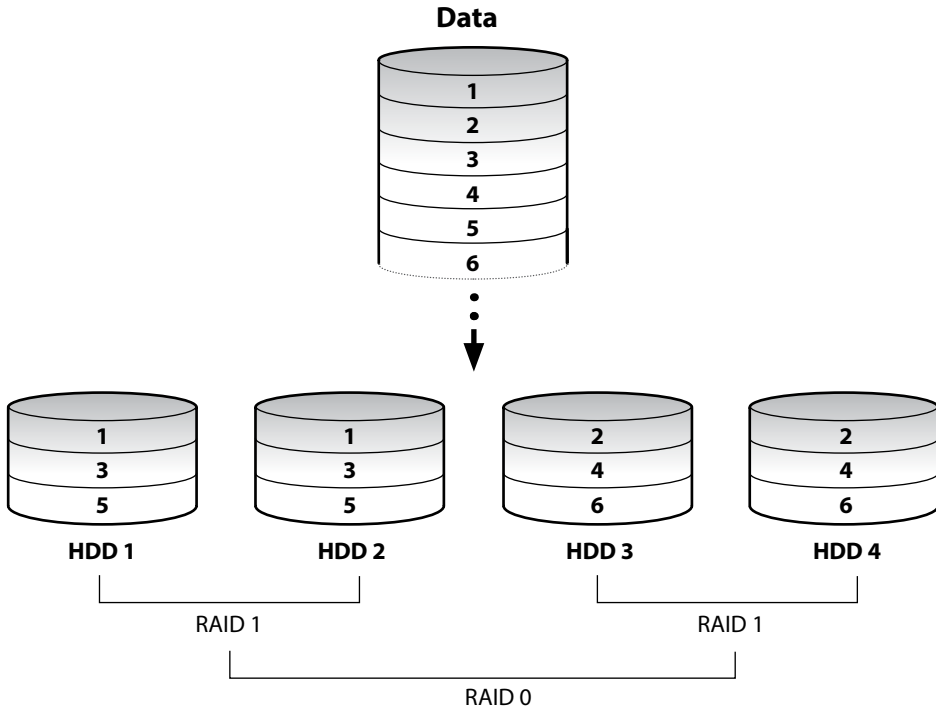

The following table shows when data will be preserved or lost, depending which hard drives failed.

(O: Preserved, X: Lost)

Failed HDD	HDD1	HDD2	HDD3	HDD4
HDD1	-	X	O	O
HDD2	X	-	O	O
HDD3	O	O	-	X
HDD4	O	O	X	-

## RAID 5

The system saves data across three out of four hard drives installed, and an identical backup is created on the fourth hard drive. Identical backups are spread across all hard drives. If one hard drive fails, the data can be preserved. Therefore, it offers fast data transfer rate as well as data security. When four hard drives are used, total capacity of the volume equals the total capacity of three hard drives. It is the most widely used method as it offers higher available capacity than RAID 1+0 when used with 4 SATA hard drives.

- Even if one of the hard drives fails, all data can be preserved. However, it is recommended that you replace the failed hard drive and rebuild RAID volume as soon as possible.

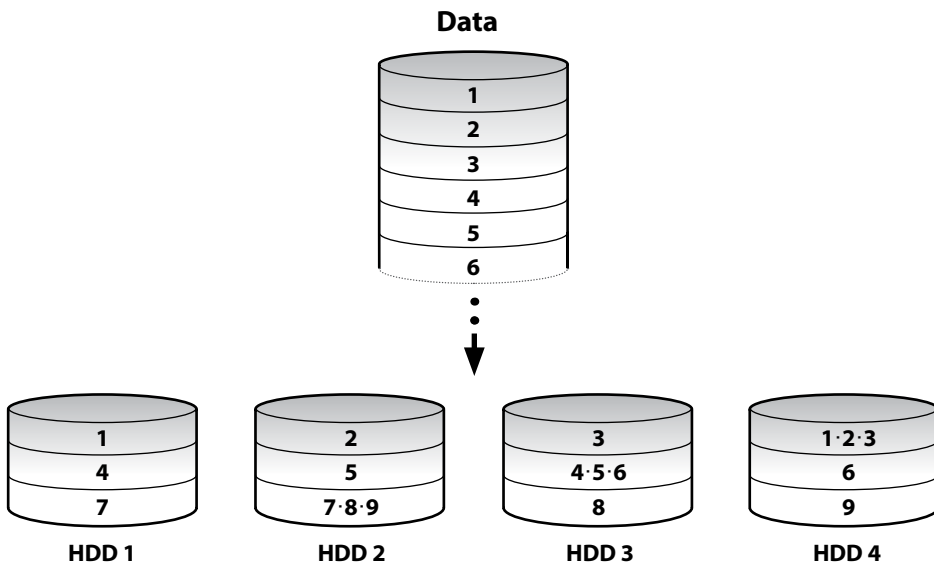

## RAID Rebuilding

When one of the hard drives fails, replace the hard drive with new one and RAID rebuilding will begin automatically.



- RAID rebuilding is not supported for the SATA Port Multiplier and RAID 0 modes.
- If you replace two hard drives at once, RAID rebuilding will proceed sequentially one by one.

- 1 When one of the installed hard drives fails, beep will sound and the LED corresponding failed HDD on the front panel will blink sequentially in green and red. Press and hold the Setup button on the front panel with the straightened paperclip for 3 seconds to turn off the audio warning.
- 2 Replace the failed hard drive with a new one and RAID rebuilding will begin automatically.

## Specifications

<b>Host connection interface</b>	External eSATA port (NVR connection) Max. transfer rate (SATA II): 3.0Gbps, Cable length: Max. 2.0m
<b>Disk connection interface</b>	SATA hard drives (Max. 4), 1.5Gbps or 3.0Gbps (Auto detection)
<b>Dimensions (W x H x D)</b>	18.90" x 1.73" x 13.62" (480mm x 44mm x 346mm)
<b>Unit weight</b>	14.1 lbs. (6.4kg)
<b>Shipping weight</b>	17.9 lbs. (8.14kg)
<b>Operating temperature</b>	41°F to 104°F (5°C to 40°C)
<b>Operating humidity</b>	0% to 90%
<b>Power supply</b>	100V ~ 240VAC, 0.6-0.3A, 50/60Hz
<b>Power consumption</b>	Max. 40W
<b>Certifications</b>	FCC, CE, CB, UL*

\* **CAUTION:** There is risk of explosion if the battery is replaced with an incorrect type. Dispose used batteries according to the instructions. This equipment is intended for indoor use only and all the communication wiring must be limited to indoors.



Specifications are subject to change without notice.



**IDIS Co., Ltd.**

For more information, please visit at  
[www.idisglobal.com](http://www.idisglobal.com)