



Digital Video Recorder

Installation Manual

TR-4208

TR-4216

TR-4208R



TR-4216R

Before reading this manual

This manual contains basic instructions on installing and using Digital Video Recorder, an IDIS product. Users who are using this product for the first time, as well as users with experience using comparable products, must read this manual carefully before use and heed to the warnings and precautions contained herein while using the product. Safety warnings and precautions contained in this manual are intended to promote proper use of the product and thereby prevent accidents and property damage and must be followed at all times. Once you have read this manual, keep it at an easily accessible location for future reference.



- 
 • The manufacturer will not be held responsible for any product damage resulting from the use of unauthorized parts and accessories or from the user's failure to comply with the instructions contained in this manual.
- It is recommended that first-time users of Digital Video Recorder and individuals who are not familiar with its use seek technical assistance from their retailer regarding product installation and use.
- If you need to disassemble the product for functionality expansion or repair purposes, you must contact your retailer and seek professional assistance.
- Both retailers and users should be aware that this product has been certified as being electromagnetically compatible for commercial use. If you have sold or purchased this product unintentionally, please replace with a consumer version.

Safety Precautions

	CAUTION	
RISK OF ELECTRIC SHOCK DO NOT OPEN		
CAUTION: TO REDUCE THE RISK OF ELECTRIC SHOCK, DO NOT REMOVE COVER (OR BACK). NO USER-SERVICEABLE PARTS INSIDE. REFER SERVICING TO QUALIFIED SERVICE PERSONNEL.		

 The lightning flash with arrowhead symbol, within an equilateral triangle, is intended to alert the user to the presence of uninsulated "dangerous voltage" within the product's enclosure that may be of sufficient magnitude to constitute a risk of electric shock.

 The exclamation point within an equilateral triangle is intended to alert the user to the presence of important operating and maintenance (servicing) instructions in the literature accompanying the appliance.

Symbol	Publication	Description
	IEC60417, No.5032	Alternating current
	IEC60417, No.5031	Direct current

Important Safeguards

1. Read Instructions

All the safety and operating instructions should be read before the appliance is operated.

2. Retain Instructions

The safety and operating instructions should be retained for future reference.

3. Cleaning

Unplug this equipment from the wall outlet before cleaning it. Do not use liquid aerosol cleaners. Use a damp soft cloth for cleaning.

4. Attachments

Never add any attachments and/or equipment without the approval of the manufacturer as such additions may result in the risk of fire, electric shock or other personal injury.

5. Water and/or Moisture

Do not use this equipment near water or in contact with water.

6. Ventilation

Place this equipment only in an upright position. This equipment has an open-frame Switching Mode Power Supply (SMPS), which can cause a fire or electric shock if anything is inserted through the ventilation holes on the side of the equipment.

7. Accessories

Do not place this equipment on an unstable cart, stand or table. The equipment may fall, causing serious injury to a child or adult, and serious damage to the equipment. Wall or shelf mounting should follow the manufacturer's instructions, and should use a mounting kit approved by the manufacturer.



This equipment and cart combination should be moved with care. Quick stops, excessive force, and uneven surfaces may cause the equipment and cart combination to overturn.

8. Power Sources

This equipment should be operated only from the type of power source indicated on the marking label. If you are not sure of the type of power, please consult your equipment dealer or local power company.

You may want to install a UPS (Uninterruptible Power Supply) system for safe operation in order to prevent damage caused by an unexpected power stoppage. Any questions concerning UPS, consult your UPS retailer.

9. Power Cords

Operator or installer must remove power and TNT connections before handling the equipment.

10. Lightning

For added protection for this equipment during a lightning storm, or when it is left unattended and unused for long periods of time, unplug it from the wall outlet and disconnect the antenna or cable system. This will prevent damage to the equipment due to lightning and power-line surges.

11. Overloading

Do not overload wall outlets and extension cords as this can result in the risk of fire or electric shock.

12. Objects and Liquids

Never push objects of any kind through openings of this equipment as they may touch dangerous voltage points or short out parts that could result in a fire or electric shock. Never spill liquid of any kind on the equipment.

13. Servicing

Do not attempt to service this equipment yourself. Refer all servicing to qualified service personnel.

14. Damage requiring Service

Unplug this equipment from the wall outlet and refer servicing to qualified service personnel under the following conditions:

- A. When the power-supply cord or the plug has been damaged.
- B. If liquid is spilled, or objects have fallen into the equipment.
- C. If the equipment has been exposed to rain or water.
- D. If the equipment does not operate normally by following the operating instructions, adjust only those controls that are covered by the operating instructions as an improper adjustment of other controls may result in damage and will often require extensive work by a qualified technician to restore the equipment to its normal operation.
- E. If the equipment has been dropped, or the cabinet damaged.
- F. When the equipment exhibits a distinct change in performance this indicates a need for service.

15. Replacement Parts

When replacement parts are required, be sure the service technician has used replacement parts specified by the manufacturer or that have the same characteristics as the original part. Unauthorized substitutions may result in fire, electric shock or other hazards.

16. Safety Check

Upon completion of any service or repairs to this equipment, ask the service technician to perform safety checks to determine that the equipment is in proper operating condition.

17. Field Installation

This installation should be made by a qualified service person and should conform to all local codes.

18. Correct Batteries

Warning: Risk of explosion if battery is replaced by an incorrect type. Dispose of used batteries according to the instructions.

19. Tmra

A manufacturer's maximum recommended ambient temperature (Tmra) for the equipment must be specified so that the customer and installer may determine a suitable maximum operating environment for the equipment.

20. Elevated Operating Ambient Temperature

If installed in a closed or multi-unit rack assembly, the operating ambient temperature of the rack environment may be greater than room ambient. Therefore, consideration should be given to installing the equipment in an environment compatible with the manufacturer's maximum rated ambient temperature (Tmra).

21. Reduced Air Flow

Installation of the equipment in the rack should be such that the amount of airflow required for safe operation of the equipment is not compromised.

22. Mechanical Loading

Mounting of the equipment in the rack should be such that a hazardous condition is not caused by uneven mechanical loading.



23. Circuit Overloading

Consideration should be given to connection of the equipment to supply circuit and the effect that overloading of circuits might have on over current protection and supply wiring. Appropriate consideration of equipment nameplate ratings should be used when addressing this concern.

24. Reliable Earthing (Grounding)

Reliable grounding of rack mounted equipment should be maintained. Particular attention should be given to supply connections other than direct connections to the branch circuit (e.g., use of power strips).

In-Text

Symbol	Type	Description
	Caution	Important information concerning a specific function.
	Note	Useful information concerning a specific function.

User's Caution Statement

Caution: Any changes or modifications to the equipment not expressly approved by the party responsible for compliance could void your authority to operate the equipment.

FCC Compliance Statement

THIS EQUIPMENT HAS BEEN TESTED AND FOUND TO COMPLY WITH THE LIMITS FOR A CLASS A DIGITAL DEVICE, PURSUANT TO PART 15 OF THE FCC RULES. THESE LIMITS ARE DESIGNED TO PROVIDE REASONABLE PROTECTION AGAINST HARMFUL INTERFERENCE WHEN THE EQUIPMENT IS OPERATED IN A COMMERCIAL ENVIRONMENT. THIS EQUIPMENT GENERATES, USES, AND CAN RADIATE RADIO FREQUENCY ENERGY AND IF NOT INSTALLED AND USED IN ACCORDANCE WITH THE INSTRUCTION MANUAL, MAY CAUSE HARMFUL INTERFERENCE TO RADIO COMMUNICATIONS. OPERATION OF THIS EQUIPMENT IN A RESIDENTIAL AREA IS LIKELY TO CAUSE HARMFUL INTERFERENCE, IN WHICH CASE USERS WILL BE REQUIRED TO CORRECT THE INTERFERENCE AT THEIR OWN EXPENSE.

WARNING: CHANGES OR MODIFICATIONS NOT EXPRESSLY APPROVED BY THE PARTY RESPONSIBLE FOR COMPLIANCE COULD VOID THE USER'S AUTHORITY TO OPERATE THE EQUIPMENT.

THIS CLASS OF DIGITAL APPARATUS MEETS ALL REQUIREMENTS OF THE CANADIAN INTERFERENCE CAUSING EQUIPMENT REGULATIONS.

WEEE (Waste Electrical & Electronic Equipment)

Correct Disposal of This Product

(Applicable in the European Union and other European countries with separate collection systems)



This marking shown on the product or its literature, indicates that it should not be disposed with other household wastes at the end of its working life. To prevent possible harm to the environment or human health from uncontrolled waste disposal, please separate this from other types of wastes and recycle it responsibly to promote the sustainable reuse of material resources.

Household users should contact either the retailer where they purchased this product, or their local government office, for details of where and how they can take this item for environmentally safe recycling.

Business users should contact their supplier and check the terms and conditions of the purchase contract. This product should not be mixed with other commercial wastes for disposal.

Copyright

© 2021 IDIS Co., Ltd.

IDIS Co., Ltd. reserves all rights concerning this manual.

Use or duplication of this manual in part or whole without the prior consent of IDIS Co., Ltd. is strictly prohibited.

Contents of this manual are subject to change without prior notice.

Registered Trademarks

IDIS is a registered trademark of IDIS Co., Ltd.

Other company and product names are registered trademarks of their respective owners.

The information in this manual is believed to be accurate as of the date of publication even though explanations of some functions may not be included. We are not responsible for any problems resulting from the use thereof. The information contained herein is subject to change without notice. Revisions or new editions to this publication may be issued to incorporate such changes.

The software included in this product contains some Open Sources. You may obtain the complete corresponding source code from us. See the Open Source Guide on the software CD (OpenSourceGuide\OpenSourceGuide.pdf) or as a printed document included along with the Manual.

Table of Contents

1

Part 1 – Introduction.....	7
Product Features	7
Accessories.....	9
Overview	10
Dimension	10
Front Panel.....	11
Rear Panel	14
Rear Panel Connections	15
Remote Control	19

2

Part 2 - Appendix.....	22
System Log Types	22
Error Code Types	23
Troubleshooting	24
Specifications	25

Part 1 – Introduction

Product Features

This is a video recorder that supports surveillance, recording, and playback of video from analog cameras.

This DVR (Digital Video Recorder) unit offers the following features:

- Real-time channels surveillance
- Compatible with Color (NTSC or PAL) and B&W (CCIR and EIA-170) Video Sources
- H.264 Codec
- Real-time 480ips video recording (standard for Full HD resolution)
- Auto Detection for NTSC and PAL / Camera Auto Detection for HD and SD
- HDMI out (1), SPOT out (1), and VGA out (1) ports at the same time
- UTC for camera menu control (controls camera menu using coax cable)
- Fast and easy search feature (Time-Lapse, Event log, Motion, Text-In)
- Simultaneously survey, record, play back, and transmit data in real-time
- Graphic User Interface(GUI) and multilingual
- Multiple recording modes (Schedule, Event, Pre-Event, and Panic)
- Continuous Recording in Disk Overwrite Mode
- 1 USB 3.0 port, 1 USB 2.0 port (for connecting peripherals, upgrading software, and saving recording data)
- Text Input for ATM and POS
- Two-way audio communication
- 4-channel audio recording and 1-channel audio playback
- 16 alarm ins, 4 alarm outs, and Built-in Alarm Buzzer
- IR remote control-enabled
- Automated system event alerts (industry standard S.M.A.R.T. protocol for HDD status alerts)

Part 1 – Introduction



This document covers the 8- and 16-channel digital video recorders. The DVRs are identical except for the number of cameras and alarms that can be connected and the number of cameras that can be displayed. For simplicity, the illustrations and descriptions in this document refer to the 16-channel model.

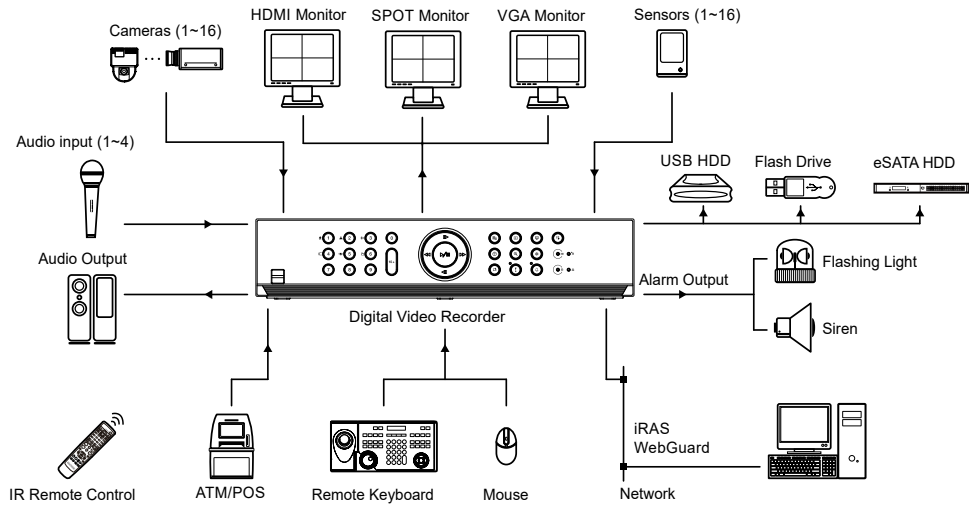

Accessories

Upon unpackaging the product, check the contents inside to ensure that all the following accessories are included.

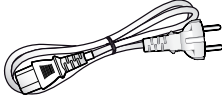
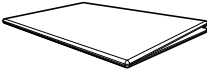
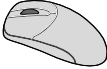
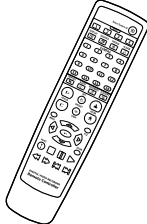
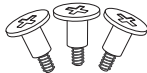
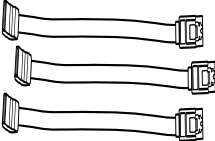
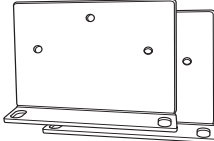
		
<p>Digital Video Recorder</p>	<p>Power Cable</p>	<p>Quick Guide</p>
		
<p>Optical USB Mouse</p>	<p>IR Remote Control</p>	<p>Assembly Screws for Adding Hard Disk Drives</p>
		
<p>SATA2 cables</p>	<p>Rack-mount Kit</p>	

Overview

Dimension

Front

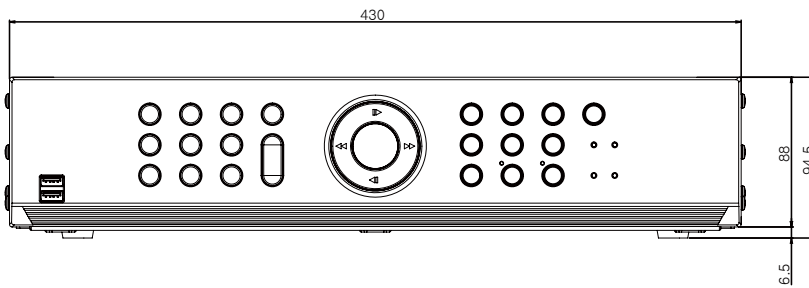

Side

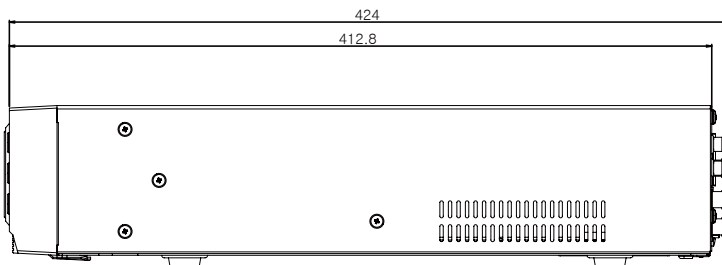

Front Panel

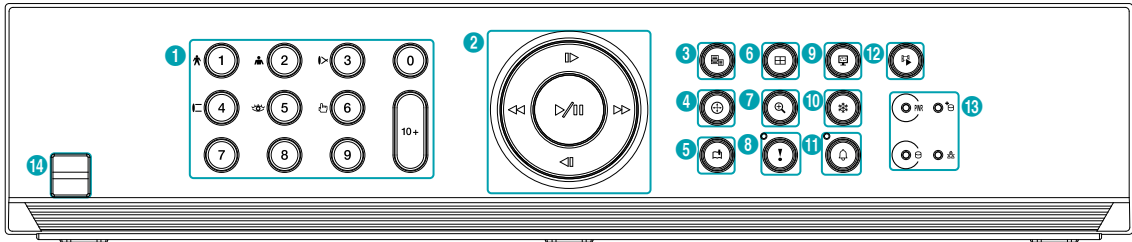

1	Camera Buttons	2	Arrow and Playback Control Buttons	3	Menu Button	4	PTZ Button
5	Bookmark Button	6	Layout Button	7	Zoom Button	8	Panic Recording Button
9	Monitor Button	10	Freeze Button	11	Alarm Button	12	Search Mode Button
13	LEDs	14	USB Ports				









- Some buttons have more than one function.
- Remote control sensor is located on the middle of the front panel. Ensure that the sensor remains unobstructed at all times. If obstructed, the sensor might not be able to receive remote control signals.
- Placing a Wi-Fi, Bluetooth, or any other wireless communication device near the DVR may interfere with remote control signal transmission.
- Access various windows and menus using a USB mouse as you would on a personal computer.
- For easier system configuration, a USB mouse is recommended.

① **Camera Buttons**



Pressing the **Camera** buttons while in Live or Playback mode displays images from the selected camera in full screen. To select a camera whose channel is made up of two digits, enter the  button.

② **Arrow and Playback Control Buttons**

These buttons are used to select menus and options.

Enter () Button	Used to select options or to register data entries.
Setup Menu	( /  /  / ) Buttons: Moves the focus up, down, left, or right. ( / ) Buttons: Increases or decreases values.
Playback Mode (When None is selected in the Control Area menu)	▶/ Button: To play the video in normal speed. ▶ is displayed on the screen. Press again during playback to pause the video and is displayed on the screen. From paused state: ◀ Button: To the previous screen ▶ Button: To the next screen ◀◀ Button: Scans backward through the video at a fast rate. (Press to cycle through ◀◀, ◀◀◀, and ◀◀◀◀ the speed) ▶▶ Button: Scans forward through the video at a fast rate. (Press to cycle through ▶▶, ▶▶▶, and ▶▶▶▶ the speed)

③ **Menu Button**

Pressing the **Menu**  button while in Live mode displays the Live menu.
Pressing the **Menu**  button while in Search mode displays the Search menu on the right of the screen. Press the button once more to close the menu.
Pressing and holding the **Menu**  button for 3 seconds activates Edit Group mode.

④ **PTZ Button**



Pressing the **PTZ**  button initiates PTZ mode, allowing you to control PTZ cameras.
In PTZ mode, use the arrow buttons to move the camera up, down, left, and right.

	Zoom-Out
	Zoom-In
	Focus Near
	Focus Far
	Preset View
	Preset Set

⑤ **Bookmark Button**

Add the current playback point to the bookmark list or move to the registered bookmark point.



⑥ **Layout Button**

Press the **Layout**  button to cycle through split screen formats.
Pressing and holding the **Layout**  button for 3 seconds allows you to select which cameras will display on the spot monitor.

⑦ **Zoom Button**

Used to zoom in on a specific part of the screen. Once zoomed in, use the arrow buttons to pan around.

⑧ **Panic Recording Button**

Pressing **Panic Recording**  button displays the  icon and commences recording irrespective of the current schedule.
Press the button again to deactivate Panic Recording mode.
Flashes in red when Panic Recording is in progress.

⑨ **Monitor Button**

Select the monitor between Main and Spot. You can select the screen format and sequence monitoring of the selected monitor.

⑩ **Freeze Button**

Used to pause Live screen.

⑪ **Alarm Button**

Pressing the **Alarm**  button while the alarm has been activated resets all DVR outputs, including the built-in buzzer. Pressing the button while the alarm is off displays the event log on the screen.
Flashes in red when an alarm event occurs.



12 Search Mode Button

Pressing the **Search Mode**  button initiates Search mode, which will allow you to search for and play back video recordings.

Pressing the **Search Mode**  button while in Search mode returns the screen to Live mode.

Pressing and holding the **Search Mode**  button for 3 seconds displays the clip copy window.

13 LEDs

- **Power LED:** Lights up while the main unit is in operation.
-  **HDD LED:** Lights up when data is being written on the HDD or a video search is in progress.
-  **eSATA LED:** Lights up when the main unit is connected to an eSATA device.
-  **Network LED:** Lights up when the main unit is linked to an ethernet.

14 USB Ports

● Storage Device Connection

Connect an external USB hard drive or a USB flash memory device to one of the USB ports for use with the Clip Copy feature. The external storage device should be placed as close to the DVR as possible. It is recommended that you use a connection cable that is no longer than 180cm in length. Use the connection cable included with your external storage device to connect the device to one of DVR's USB ports. For more information Clip Copy, refer to the **Clip Copy in the operation manual**.

● Peripheral Device Connection

Use the USB ports to connect peripherals such as a USB mouse to the DVR. You can also use a USB-to-serial converter and connect multiple text-in devices to the DVR at the same time.



For USB flash memory devices, the DVR supports the FAT32 file format only.

Connections on the Front Panel

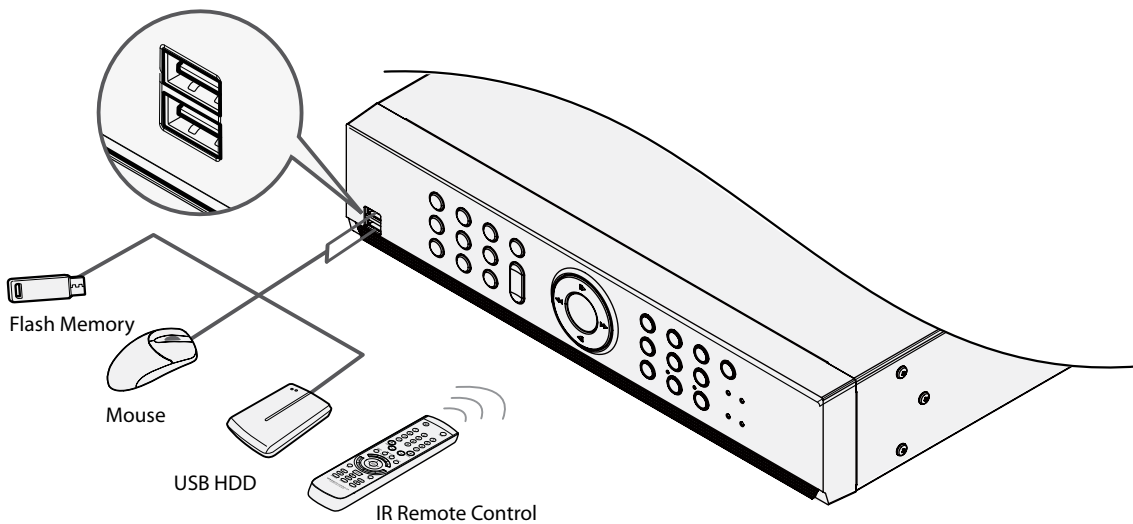

Rear Panel

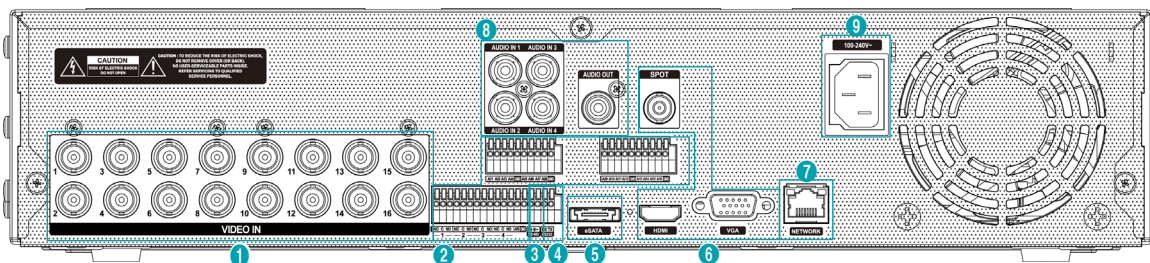

1	Video Input	2	Alarm Connection Ports	3	RS-485 Port
4	RS-232 Port	5	eSATA Port	6	SPOT / HDMI / VGA Out Port
7	Network Port	8	Audio In / Out	9	Power In Port

Rear Panel Connections

Video Connection

Video Input

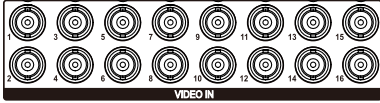

Connect the coaxial cables from the video sources to the composite Video In connectors or BNC connectors.

Alarm Connection

Connect alarm connectors to these ports.

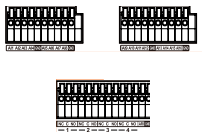

Press down on the button and insert the cable into the opening. Release the button and then pull on the cable slightly to ensure it is held securely in place. To disconnect the cable, press down on the button again and pull the cable out.

• Alarm In 1 through 16

This DVR is capable of responding to event signals from external alarm in devices. Connect mechanical or electrical switches to AI 1 through 16 and the GND (ground) connector. In order to be recognized by the DVR, the signal from an alarm in device must be less than 0.3V (Normally Open) and maintained for at least 0.5 seconds. The alarm in voltage range is 0V to 5V. For more information on alarm in setup, refer to the **Alarm-In in the operation manual**.

• GND (Ground)

Connect alarm in or out's ground cable to the GND connector.



All connectors marked "GND" are common connectors.

• NC/NO (Relay Alarm Outputs)

This DVR is capable of activating/deactivating buzzers, lights, and other external devices. Connect the device to the C and NO (Normally Open) connectors. NC/NO is a relay output which sinks 2A@125VAC and 1A@30VDC. For more information on alarm out setup, refer to the **Alarm-Out in the operation manual**.

• ARI (Alarm Reset In)

An external signal to the Alarm Reset In can be used to reset both the Alarm Out signal and the DVR's internal buzzer. Mechanical or electrical switches can be wired to the ARI (Alarm Reset In) and GND (Ground) connectors. The threshold voltage is below 0.3V and should be stable at least 0.5 seconds to be detected. Connect the wires to the ARI and GND connectors.

• Connector Arrangement

AI1 through AI16	Alarm In 1 through 16
GND	Ground
NC	Relay Alarm Out (Normally Closed)
C	Relay Common
NO	Normally Open Relay Alarm Out
ARI	Alarm Reset In

RS-485 Connection

This DVR supports the RS-485 half-duplex serial communication protocol for connecting to external devices such as POS units. The RS-485 connector can also be used to control PTZ (pan, tilt, zoom) cameras. Connect RX+/TX+ and RX-/TX- of the control system to the + and - (respectively) of the DVR.



• **Connector Pin Outs**

Master Unit	Slave Unit
+ → To → TX+/RX+	
- → To → TX-/RX-	

RS-232 Connection

Connect an external device such as a POS unit to this port.



• **Connector Pin Outs**

Master Unit	Slave Unit
RX → To → TXD	
TX → To → RXD	
GND → To → GND	

Refer to the following for pin-out details for the 9-pin connector of the slave unit.

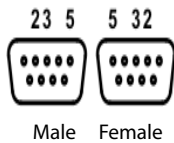

Pin 2	RXD (Receive Data)
Pin 3	TXD (Transmit Data)
Pin 5	GND (Ground)

eSATA Connection

Connect external hard drives to these ports.



Do not connect or disconnect an eSATA device while the DVR is powered on. To connect an eSATA device, first turn off the DVR and unplug the power cable. Connect the eSATA device and then power the eSATA device first and then DVR back on. To disconnect an eSATA device, first turn off the DVR and unplug the power cable. Turn off the eSATA device and then disconnect the eSATA connection cable.

Monitor Connection

Connect to the **SPOT**, **VGA OUT**, or **HDMI** port.

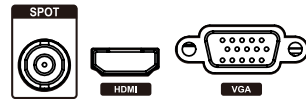

Network Connection

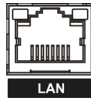

This DVR is capable of connecting to networks via the 10Mb/100Mb/1Gb ethernet connector. Connect an RJ-45 cable (Cat5e) to the DVR's network port. It's possible to operate and upgrade the DVR remotely over a network. For more information on ethernet connection setup, refer to **Network Setup in the operation manual**.



Connector directions may vary depending on the DVR model.

Audio Connection

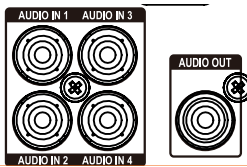

Connect the audio device to the **AUDIO IN** port and speakers with a built-in amplifier to the **AUDIO OUT** port. Use the **AUDIO OUT** port to listen to audio from analog cameras.

Use the **AUDIO IN** port to establish two-way communication with cameras.



- This DVR does not feature a built-in audio amplifier unit and therefore requires the user to purchase a speaker system with a built-in amplifier separately. It's possible to connect an amplified audio source to the DVR, but microphones that do not have a built-in amplifier will not function properly if connected to the DVR directly. If this is the case, connect the microphone to the DVR via a pre-amp.
- Check your local laws and regulations on making audio recordings.

Power Cable Connection

Connect the power cable to this port. This DVR does not feature a separate power on/off button and will turn on the moment power is supplied.



- Organize the power cable so that it will not cause people to trip over or become damaged from chairs, cabinets, desks, and other objects in the vicinity. Do not run the power cable underneath a rug or carpet.
- The power cable is grounded. Do not modify the power plug even if your power outlet does not have a ground contact.
- Do not connect multiple devices to a single power outlet.

Connections on the Rear Panel

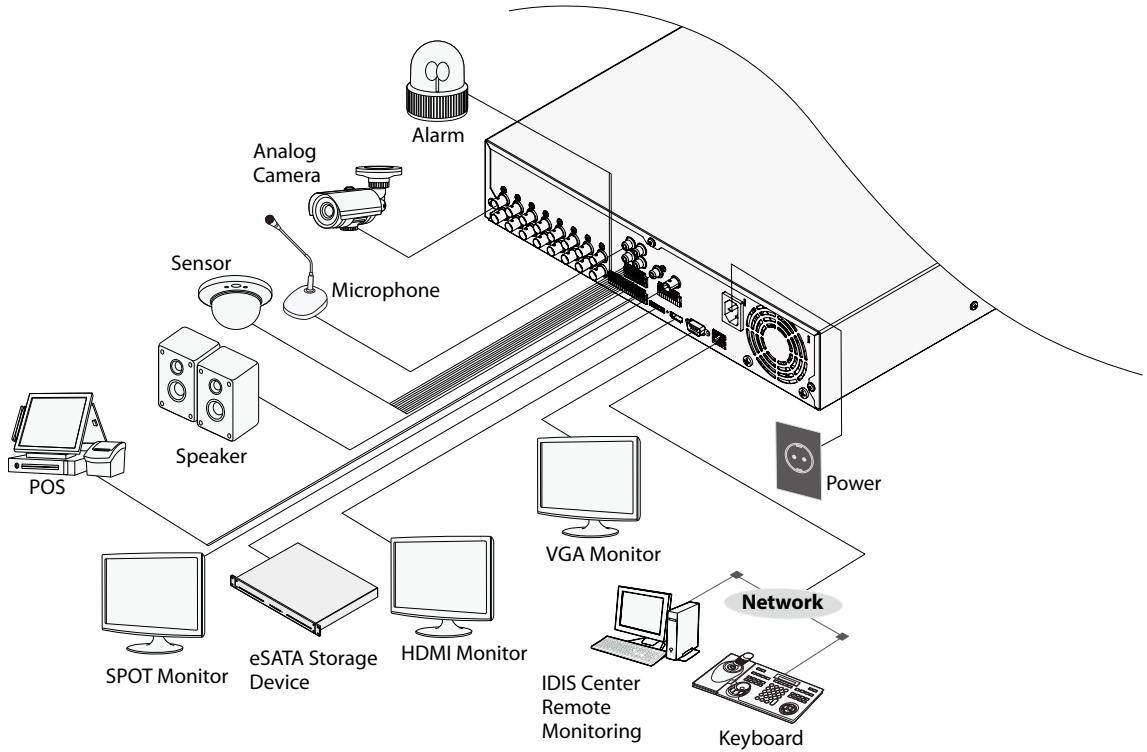

Remote Control

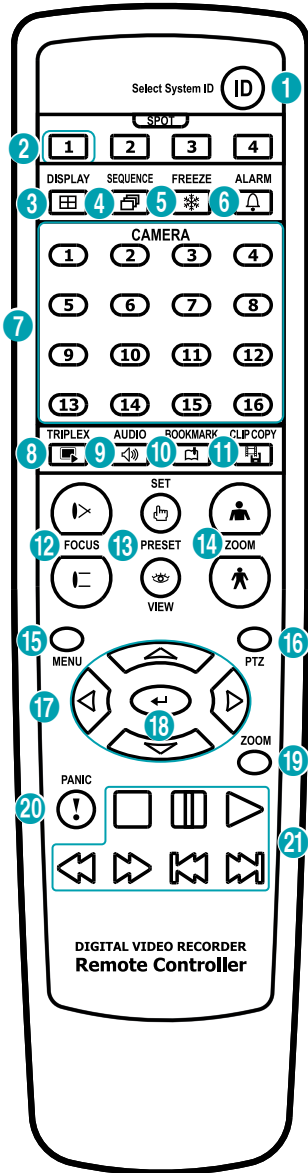

1	ID Button
2	SPOT Button
3	DISPLAY Button
4	SEQUENCE Button
5	FREEZE Button
6	ALARM Button
7	Camera Buttons
8	TRIPLEX Button
9	AUDIO Button
10	BOOKMARK Button
11	CLIP COPY Button
12	FOCUS NEAR/FAR Button
13	PRESET SET/VIEW Button
14	ZOOM IN/OUT Button
15	MENU Button
16	PTZ Button
17	Arrow Buttons
18	Enter Button
19	ZOOM Button
20	PANIC Button
21	Playback Buttons

① **ID** Button

Used to assign remote control ID values.

No additional remote control assignment is necessary if the system's ID is 0. If the system's ID is a number between 0 and 16, however, you will need to press the ID button and then press the system ID number on the remote control. If the system's ID is set in double digits, press each digit button consecutively. The  (remote control) icon will appear on the bottom of the DVR screen (status indication area) to indicate successful system-to-remote control pairing. If using multiple systems, it's possible to control all the units with a single remote control as long as all the system IDs are 0.

② **SPOT** Button

Select a camera or sequence that appear in the spot monitor. Spot monitor only supports the full screen.

③ **DISPLAY** Button

PIP > 2x2 > 1+5 > 1+7 > 3x3 > 4x4

④ **SEQUENCE** Button

Pressing the **SEQUENCE** button while in Live mode initiates Live Sequential mode (displays channels in sequence).

⑤ **FREEZE** Button

Used to pause Live screen.

⑥ **ALARM** Button

Pressing this button while the alarm has been activated resets all DVR outputs, including the built-in buzzer. Displays the event log on the screen when the alarm is off in Live mode.

⑦ **Camera** Buttons

Pressing the **Camera** button while in Live or Playback mode displays images from the selected camera in full screen.

⑧ **TRIPLEX** Button

The DVR supports the Triplex function: monitoring, recording and playing back at the same time.

⑨ **AUDIO** Button

Enable/disable audio.

⑩ **BOOKMARK** Button

Adds a bookmark to the current playback position.

⑪ **CLIP COPY** Button

Pressing the **CLIP COPY** button allows you to copy video clips.

⑫ **FOCUS NEAR/FAR** Button

Used in PTZ mode to shift focus between a nearby point and a far away point.

⑬ **PRESET SET/VIEW** Button

Press the **SET** button while in PTZ mode to save the current position as a preset. Pressing the **VIEW** button displays the preset list.

⑭ **ZOOM IN/OUT** Button

Used in PTZ mode to zoom in/out on the screen.

⑮ **MENU** Button

Pressing the **MENU** button while in Live mode displays the Live menu. Alternatively, pressing the button while in Search mode displays the Search menu. Press the button once more to close the menu. Use the arrow buttons to select menus and options.

⑯ **PTZ** Button

Initiates PTZ mode and allows you to control the selected PTZ camera.

⑰ **Arrow** Buttons

Used to navigate through menus and interact with GUIs. In a Setup menu, use the **Up/Down Arrow** buttons to increase or decrease numerical values. In Live or Playback mode, use the **Left/Right Arrow** buttons to view the previous or next screen.

⑱ **Enter** Button

Used to make menu option selections and register data entries. In addition, pressing this button while a camera screen is selected by pressing the **Menu** button in Live or Playback mode displays the Camera menu.

⑲ **ZOOM** Button

















Used to zoom in on a specific part of the screen. Once zoomed in, use the arrow buttons to pan around.

⑳ **PANIC** Button

Pressing this button displays the  icon and commences recording irrespective of the current schedule.

Press the button again to deactivate Panic Recording mode.

② Playback Buttons

	<p>Stops the video and restores Live mode.</p> <p>Pressing the  button during monitoring appears the window that selects between triplex and all channels modes.</p>
	<p>Pressing the  button during playback pauses the video and displays  on the screen.</p>
	<p>Plays the video in normal speed and displays  on the screen.</p>
	<p>Scans backward through the video at a fast rate (Press to cycle through , , and  the speed).</p>
	<p>Scans forward through the video at a fast rate (Press to cycle through , , and  the speed).</p>
	<p>Skips to the previous screen (while in paused state).</p>
	<p>Skips to the next screen (while in paused state).</p>

Part 2 - Appendix

System Log Types





Boot Up	Panic Off
System Shutdown	Clear All Data
Restart	Clear Disk
Upgrade Success	Format Disk
Upgrade Error	Disk Full
Power Failure	Disk Config Change
Time Changed	Disk 'No.' : 'serial number'
Time Zone Change	Disk 'No.' : Removed
Time Sync.	Auto Deletion
Time Sync. Failed	Search Begin
Disk Bad	Search End
Login	Clip-Copy Begin
Logout	Clip-Copy End
Setup Begin	Clip-Copy Cancel
Setup End	Clip-Copy Failure
Remote Setup Change	Clip Copy User
Remote Setup Failure	Clip-Copy Begin
Setup Import	Clip-Copy Finished
Setup Import Failure	Clip Copy Duration of Video
Setup Export	Clip Copy Camera
Setup Export Failure	Callback Failed
Setup Export Canceled	Factory Reset
Schedule On	Print Begin
Schedule Off	Print End
Connected : NetFS :	Print Cancel
Disconnected : NetFS :	Login : VNC (server address)
Panic On	Logout : VNC (server address)

Error Code Types

Upgrade Error Codes			
No.	Type	No.	Type
0	Unknown Error	301	Remote Network Error
1	Incorrect File Version	302	No Remote Upgrade Permission
2	Incorrect OS Version	303	Remote Upgrade File Save Failure
3	Incorrect Software Version	304	Remote Upgrade Cancelled by User
4	Incorrect Kernel Version	400	USB Storage Device Mount Failure
100	Storage Device Mount Failure	401	USB Storage Device File Read Failure
101	File Not Found	402	USB Storage Device File Copy Failure
102	File Decompression Failure	403	USB Device Not Connected
103	LILO Execution Failure	404	USB Storage Device in Use
104	Reboot Failure	405	Unsupported File System
105	Improper File	500	Clip Copy in Progress: Upgrade Not Available
300	Remote Connection Failure		

Clip Copy Error Codes			
No.	Type	No.	Type
0	Unknown Error	11	Save Failure
1	Device Error	12	Disk Error
2	Device Connection Failure	13	Clip Player Execution File Not Found
4	Incorrect Media	14	Clip Player Execution File Access Failure
5	File Name Taken	15	Clip Player Execution File Save Failure
6	Insufficient Space	16	Image Generation Failure
7	Temporary File Generation Failure	19	Device Connection Failure
8	Disk Access Failure	20	Device in Use
9	Disk Format Failure	21	Unsupported File System
10	Database Changed	22	Data Validation Failure

Troubleshooting

Problem	Solution
The main unit won't turn on.	<ul style="list-style-type: none"> ● Check the power cable connection status. ● Check the power outlet.
Unable to display Live video.	<ul style="list-style-type: none"> ● Check the camera's video cable connection status. ● Check the monitor's video cable connection status. ● Check the camera's power setting. ● Check the camera lens settings. ● Check the current main monitor resolution.
DVR stopped working in the middle of a recording.	Set the DVR to Recycle mode. For more information, refer to the <u>General in the operation manual</u> .
 icon is shown, but video is not being recorded.	If the Pre-Event is enabled, the  and  icons appears when recording is not in progress, or the  and  icons appear when an event occurs and recording is in progress. For more information, refer to the <u>Schedule in the operation manual</u> .

Specifications

These product specifications may change without prior notice.

General	
Exterior Dimensions (W x H x D)	430mm x 88mm x 413mm
Weight (Main Unit)	5.9kg(with 2HDDS)
Working Temperature	0°C – 40°C
Operating Humidity	0% – 90%
Power Input	100 to 240 V~, 50/60Hz, ≤ 2.0A
Power Consumption*	100 to 240 V~, 50/60Hz, 1.2-0.6A, 76W
Certifications	FCC, CE, UL, CB, PSE

Video	
Video In	Composite 8 or 16 inputs: BNC, 1 Vp-p, auto-terminating, 75 Ohms
Monitor Out	HDMI: 1 VGA: 1 SPOT: 1 BNC, 1 Vp-p, 75 Ohms
Video Resolution	HDMI: 3840x2160, 1920x1080, 1440x900, 1280x1024 VGA: 1920x1080, 1440x900, 1280x1024 Composite (SPOT): 704x480 (NTSC), 704x576 (PAL)
Recording Speed (IPS)	Real-time: 480ips @ Full HD
Playback Speed (IPS)	Full Duplex: 120ips @ Full HD

I/O	
Alarm In	8 or 16 TTL, NC/NO programmable, 2.4V (NC) or 0.3V (NO) threshold, 5V DC
Alarm Out	4 relay outputs, NC/NO programmable, 2A@125V AC, 1A@30V DC
Alarm Reset In	1 TTL, terminal block
Internal Buzzer	78dB at 10cm
Network Connection	10Mbps/100Mbps/1Gbps Ethernet
Audio In	4 lines, RCA
Audio Out	1 line, RCA
Text In	POS Interface, ATM Interface

* When four hard disk drives of 3TB are installed, the value was measured.

Connectors	
Video In	Composite 8 or 16 inputs: BNC 1 Vp-p, auto-terminating, 75 Ohms
Monitor Out	HDMI: 1 VGA: 1 SPOT: 1 BNC, 1 Vp-p, 75 Ohms
Audio In	4 RCA connectors
Audio Out	1 RCA connector
Alarm	Terminal blocks
Ethernet Port	1 RJ-45
eSATA Port	eSATA
RS-232 Serial Port	Terminal blocks
RS-485 Serial Port	Terminal blocks
IR Remote Control Port	Remote Control
USB Ports	1 x USB 3.0, 1 x USB 2.0

Storage	
Primary Storage	SATA hard disk drive (up to 4)
Secondary Storage	USB hard disk drive or flash drive

 Some hard disks may not function properly when mounted on to this product. Refer to the compatibility chart below before mounting any additional hard disk on to the product. Hard disk compatibility chart is subject to change without notice. Contact your retailer for the latest compatibility chart.

Storage	Manufacturer	Model	Note
1TB	TOSHIBA	DT01ABA100V	
	Western Digital	WD10PURZ-85U8XY0	
2TB	Western Digital	WD20PURZ-85GU6Y0	
		WD20PURZ-74AKKY0	
		WD20PURZ-85AKKY0	
	Seagate	ST2000VX003	
3TB	Western Digital	WD30PURZ-85GU6Y0	
	Seagate	ST3000VX006	
4TB	Western Digital	WD40PURZ-85TTDY0	
		WD40PURZ-74AKKY0	
		WD40PURZ-85AKKY0	
	Seagate	ST4000VX000	
6TB	Western Digital	WD60PURZ-85ZUFY1	



IDIS Co., Ltd.

For more information, please visit at
www.idisglobal.com