



DirectIP PoE Switch

Operation Manual

DH-2026PF

Before reading this manual

This operation manual contains basic instruction on installing and using DirectIP PoE Switch, an IDIS product. Users who are using this product for the first time, as well as users with experience using comparable products, must read this operation manual carefully before use and heed to the warnings and precautions contained herein while using the product. Safety warnings and precautions contained in this operation manual are intended to promote proper use of the product and thereby prevent accidents and property damage and must be followed at all times.

Once you have read this operation manual, keep it at an easily accessible location for future reference.



- Unauthorized reproduction of this manual is prohibited.
- The manufacturer will not be held responsible for any product damage resulting from the use of unauthorized parts and accessories or from the user's failure to comply with the instructions contained in this operation manual.
- It is recommended that first-time users of DirectIP PoE Switch and individuals who are not familiar with its use seek technical assistance from their retailer regarding product installation and use.
- If you need to disassemble the product for functionality expansion or repair purposes, you must contact your retailer and seek professional assistance.
- Both retailers and users should be aware that this product has been certified as being electromagnetically compatible for commercial use. If you have sold or purchased this product unintentionally, please replace with a consumer version.

Safety Symbols

Symbol	Type	Description
	Warning	An important instruction or set of important instructions that can lead to severe injury or even death if not followed.
	Caution	An instruction or set of instruction that can lead to personal injury and/or property damage if not followed.

In-Text

Symbol	Type	Description
	Caution	Important information concerning a specific function.
	Note	Useful information concerning a specific function.

Safety Precautions

Information contained in this section of the manual serve to prevent accidents and property damage through proper use of the product. Please read the following instructions carefully and follow them at all times.



Warning Failure to comply can lead to severe injury or even death.

Installation

Make sure to turn off the product before installing it and to use a dedicated power outlet.

- Presents overheating, fire, and electric shock hazards.

Do not use the product in an excessively hot, cold, or humid environment.

- Presents a fire hazard.

Set up the product in a shaded area providing protection against exposure to direct sunlight and maintain an even ambient temperature. Do not set up the product in the vicinity of heat-generating objects and appliances such as candles and heaters.

- Presents a fire hazard.

There are high-voltage components inside the product. Do not attempt to open the cover or disassemble, repair, or modify the product.

- Presents fire, electric shock, and physical injury hazards.

Connection ports on the rear of the product protrude out slightly, and placing the back of the product too close to a wall will cause the cables to bend excessively and even break. Maintain a distance of at least 15cm between the back of the product and the wall it faces.

- Presents fire, electric shock, and physical injury hazards.

Do not use the product in an particularly humid, dusty, or sooty environment.

- Presents electric shock and fire hazards.

Always keep the operating environment clean and free of dust. Use a piece of dry cloth to clean the product. Do not use water, thinner, or organic solvents.

- Failure to do so can damage the product's finish and presents an electric shock hazard.

Power

Voltage fluctuation of the power supply must be within 10% of the voltage rating, and the power outlet must be grounded. Do not plug in electrical appliances such as a hair dryer, iron, and refrigerator into the same power outlet as the product.

- Presents overheating, fire, and electric shock hazards.

Do not bend the power cable excessively or place heavy objects on top of it.

- Presents a fire hazard.

Do not pull on the power cable or handle the power plug with wet hands. Do not insert the power plug into a loose power outlet.

- Presents fire and electric shock hazards.

You may want to install a UPS (Uninterruptible Power Supply) system for safe operation in order to prevent damage caused by an unexpected power stoppage. Any questions concerning UPS, consult your UPS retailer.

Product Use

Do not place a cup or container filled with a liquid on top of the product.

- The liquid may spill over and damage the product's internals and cause a fire hazard.

Avoid dangerous situations such as placing the product or its power cable on a humid/wet floor, using an ungrounded extension cord, using a damaged (exposed) power cable, and failing to properly ground the product. Contact the retailer or a specialist if you encounter a problem.

- Presents fire and electric shock hazards.

If there is a strange noise or smell coming from the product, unplug the power cable and contact the service center right away.

- Presents fire and electric shock hazards.



Caution

Failure to comply can lead to minor injury and/or product damage.

Installation

Do not set up the product in an area that is exposed or susceptible to strong magnetism, radio waves, and/or impact and avoid setting up the product in the vicinity of wireless transmission devices such as a radio or a television.

- Set up the product in an area devoid of magnetic objects, radio waves, and vibrations.

Set up the product in an open and well-ventilated area.

- Environmental factors greatly affect the product's performance and durability. Allow at least 15cm of clearance behind the product and at least 5cm of clearance on either side of the product.

Set up the product on a flat and stable surface. Do not stand the product on its side or at an angle.

- The product may tip over or drop on the floor, which can lead to a malfunction and/or personal injury.

Ensure the product's power plug is easily accessible.

- It must be easy to pull out the power plug in the event of a serious malfunction or fire.

Do not set up the product in an area susceptible to strong impact or vibrations.

- Failure to do so can cause the product to malfunction.

Product Use

Do not allow conductive objects to enter inside the product's ventilation openings.

- Failure to do so can cause the product to malfunction.

Do not place heavy objects on top of the product.

- Failure to do so can cause the product to malfunction.

Do not unplug the power cable or pick up/move the product while it is in operation.

- Failure to do so can cause the product to malfunction.

Always remember to turn off the product before connecting an optical cable.

Do not remove the optical cable's rubber cover until it's time to connect it to the product. The cover protects the cable from contamination. Once removed, store it at a safe location for future use.

Do not look directly into the tip of the optical cable or the laser beam emitting through it. In addition, do not point the laser at your eyes.

Regularly inspect the operating status of the product and contact the retailer or service center right away if any issues are identified.

Table of Contents

1

Part 1 - Introduction 8

Product Features	8
Accessories	10
Overview	10
Front Panel	10
Rear Panel	16

2

Part 2 - Installation 17

Tools for Installation	17
Mounting to a Rack	17
Installation	18
Port Connection	19
DirectIP™ NVR Connection	19
DirectIP™ Camera Connection	21
Cascading	22
Port Connection Warnings and Tips	24

3

Part 3 - Miscellaneous 25

Supported SFP Transceiver Module List	25
Troubleshooting	26
Specifications	27

Part 1 - Introduction

This multi-port, DirectIP™-based, and IEEE 802.3af and IEEE 802.3at Power over Ethernet-enabled layer2 fast Ethernet PoE Switch offers the following features:

This PoE switch is able to provide data and power at the same time to the connected network cameras through Ethernet cables by using PoE-enabled ports. It does not need a separate power outlet for each network camera and it will reduce the installation costs.

This two uplink combo ports of this product are able to selectively connected to RJ-45 connectors supporting 10/100 / 1000BASE-T or SFP connectors supporting 1000BASE-X. The remaining service ports are comprised of RJ-45 connectors that support PoE and 10/100BASE-TX. These various ports enable users to install and utilize for different network environments.

Product Features

- **DirectIP**

- Automatic network IP configuration
- Individual port data transmission to DirectIP NVR (Network Video Recorder)

- **PoE**

- IEEE 802.3af/at compliant
- Power to application over Ethernet cabling
- Central power control for greater network utility
- PoE alternate A power supply



Power feeding over 1/2 & 3/6 data twisted.

- **Advanced Interface**



- 100Mbps data transfer rate on service ports
- 1Gbps data transfer rate on uplink combo ports

- **Switch Function**

- Standard Ethernet bridge
- Loopback detection and port Blocking connections

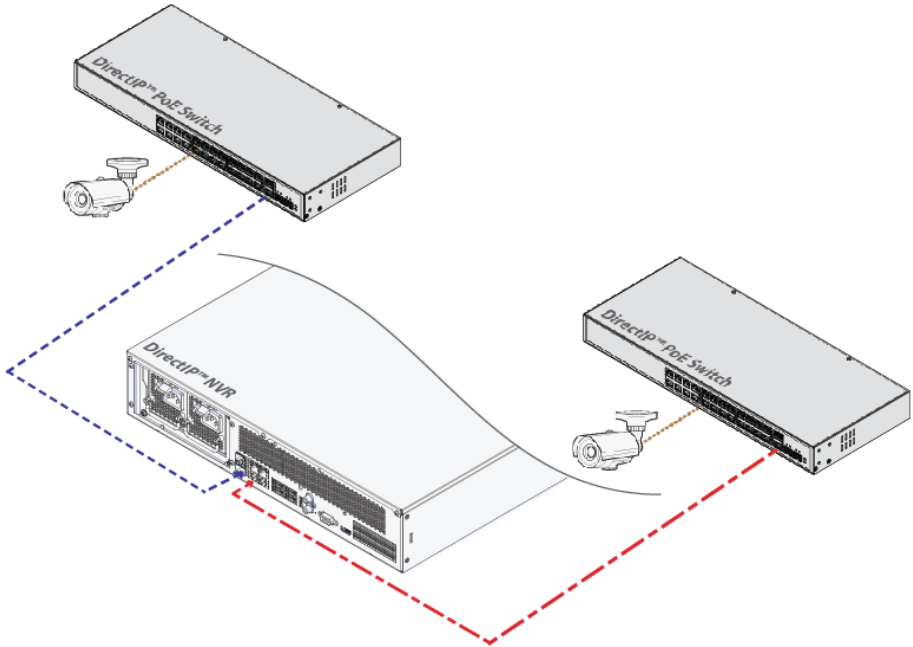
DirectIP™ PoE Switch Connection Diagram



Types of Cables	
	UTP Cable (Data only)
	UTP Cable (Data + PoE)
	Optical cable

Accessories

Upon unpackaging the product, check the contents inside to ensure that all the following accessories are included.

- DH-2026PF
- Power Cable
- Manual
- Rack Mount Brackets: 2EA
- Screws : 6EA
- Rubber Feet : 4EA

Overview

Front Panel

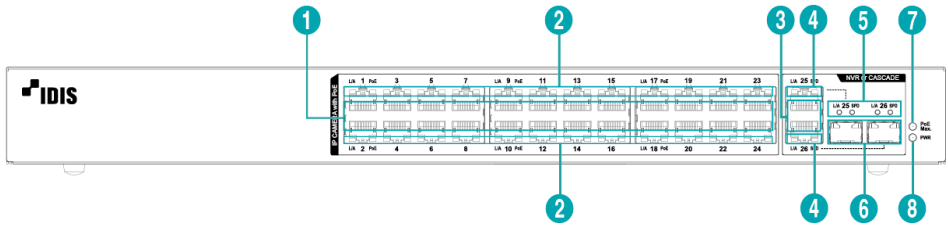

1	RJ-45 Service Ports	2	RJ-45 Service Port LEDs	3	RJ-45 Uplink combo Ports
4	RJ-45 Uplink combo Port LEDs	5	SFP(Optical) Uplink combo Port LEDs	6	SFP(Optical) Uplink combo Port
7	PoE Max. LED	8	Power LED		

① RJ-45 Service Ports

These are PoE-enabled RJ-45 ports. Connect a network camera to one of these ports.

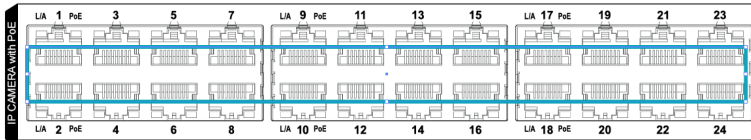

- PoE-supported network cameras will receive power over the signal line, without the use of an external power source.
- Each port is enabled with Auto-MDI/MDI-X detection and operates as a 10/100Mbps full/half duplex mode.

② RJ-45 Service Port LEDs

These LEDs indicate the status of the RJ-45 service ports.

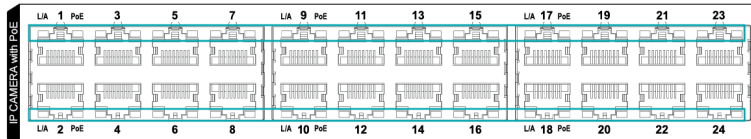

- The LED color indicates connection and communications speeds with the connected device.
- Each LED indicates L/A (network link/activity) or PoE status based on the position of the PoE LED button.

LED Status Indications

Mode	Status	Color	Description
L/A (Link/Activity)	On	Amber	Normal network connection at 10/100Mbps
	Blinking	Amber	Data transmission over the network in progress at 10/100Mbps
	Off for more than 10 seconds after On	Amber	The port is in a loopback state, and the connection is blocked
	Off	-	No network connection or a problem with the connection
PoE	On	Green	Connected and transmits power over the network normally to a PoE-supported network camera
	Blinking	Green	Event occurs to a PoE power related
	Off	-	Not connected to a PoE-supported network camera

③ RJ-45 Uplink Combo Ports

RJ-45 uplink combo ports are used to connect the switch to a higher tier device. These ports are useful when cascading multiple network devices.

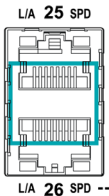

- If not using for uplinking purposes, these ports can be used as service ports.
- Each port is enabled with Auto-MDI/MDI-X detection.
- The ports operate in different modes based on the network speed. (10/100Mbps: full/half duplex, 1000Mbps: full duplex)

④ **RJ-45 Uplink Combo Port LEDs**

These LEDs indicate the status of the RJ-45 uplink combo ports.

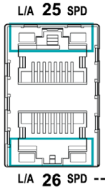

- The LED color indicates connection and communications speeds with the connected device.

LED Status Indications

Mode	Status	Color	Description
LA (Link/Activity)	On	Amber	Normal network connection at 10/100/1000Mbps
	Blinking	Amber	Data transmission over the network in progress at 10/100/1000Mbps
	Off for more than 10 seconds after On	Amber	The port is in a loopback state, and the connection is blocked
	Off	-	No network connection or a problem with the connection
SPD (Speed)	On	Green	Normal network connection at 1000Mbps
	Off	-	No network connection at 1000Mbps

Uplink combo port operation priority information

For both the SFP combo port and the RJ-45 combo port are connected to one combo port, the SFP combo port will behave with priority over the RJ-45 combo port regardless of the order of the connection.

⑤ SFP(Optical) Uplink combo Port LEDs

These LEDs indicate the status of the SFP uplink combo ports.



The LED color indicates connection and communications speeds with the connected device.

LED Status Indications

Mode	Status	Color	Description
LA (Link/Activity)	On	Amber	Normal network connection at 10/100/1000Mbps
	Blinking	Amber	Data transmission over the network in progress at 10/100/1000Mbps
	Off for more than 10 seconds after On	Amber	The port is in a loopback state, and the connection is blocked
	Off	-	No network connection or a problem with the connection
SPD (Speed)	On	Green	Normal network connection at 1000Mbps
	Off	-	No network connection at 1000Mbps

⑥ SFP Uplink Port

These SFP uplink combo ports are used to connect the switch to higher tier devices. These ports are useful when cascading multiple network devices.

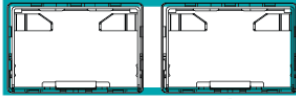

- If not using for uplinking purposes, these ports can be used as service ports but they do not support PoE.
- Each port operated in different modes based on the network speed. (100Mbps mode, 1000Mbps mode)

⑦ PoE Max. LED

PoE Max. LED indicates PoE statuses.

LED Status Indications

Mode	Status	Color	Description
PoE Max.	On	Red	Power from a PoE-supported network camera connected to the RJ-45 service port is close to the maximum level allowed.
	Blinking	Red	The amount of PoE power that could be supplied to the RJ-45 service ports is not enough to ensure IEEE 802.3af 1 port (15.4W)
	Off	-	Normal to supply power to the PoE-supported network cameras which are connected to the RJ-45 service ports.

⑧ Power LED

Power LED indicates the system's power on/off status.

The LED lights up in red to indicate the system is powered on.

Rear Panel

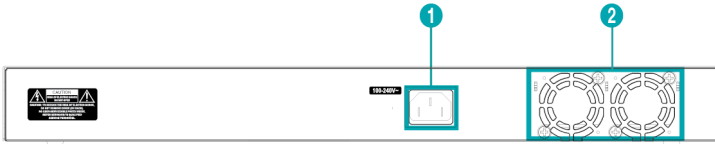

1	Power Connector	2	Vent
---	-----------------	---	------

1 Power Connector

Connect the power cable to this connector. This product does not feature a separate power on/off button and will turn on the moment power is supplied.



- Organize the power cable so that it will not cause people to trip over or become damaged from chairs, cabinets, desks, and other objects in the vicinity.
- Do not run the power cable underneath a rug or carpet.
- The power cable is grounded. It's plug, however, should not be modified even if the power outlet does not feature a grounding contact.
- Use a dedicated power outlet.

Part 2 - Installation

Tools for Installation

Check the following accessories. You will need more tools beside the accessories which are not provided.

- DH-2026PF
- Power Cable
- Manual

Tools for mounting to a rack

- Rack Mount Brackets: 2EA, Screws: 6EA
- Regular headed screwdriver: Medium (0.6 cm)

Tools for removing top or bottom cover

- Regular headed screwdriver: Small (0.3 cm)

Mounting to a Rack



You may drop the product or be injured while mounting the product to a rack or unmount it. To prevent the damage or injury, please keep the followings:

- If you mount only one product on a rack, mount it at the utmost bottom.
- If you mount more than one product on a rack, mount the heavier product at the bottom.



Make sure that the amount of airflow is enough between the products or with the wall, floor, or ceiling to prevent the product from being overheated.:



- 6 screws are provided for rack mount bracket. Please keep them in a safe place.
- If a safety base is provided with a rack, you can mount the product more safely and easily by using the safety base.

Part 2 - Installation

Installation

- 1 Place the product in a even and safe place, and prepare for a regular headed screwdriver of medium size (0.6 cm).
- 2 Using a cross screwdriver, attach the bracket to both corners of the product, as shown in the first illustration below (how to install the bracket on the product). The screw used is screw provided with the product, and the brackets are attached with 6 screws.
- 3 Move the bracket-attached switch to the location to be installed in the rack and attach the bracket part to the rack as shown in the second figure below (how to rack the product). The screws used should be prepared separately.

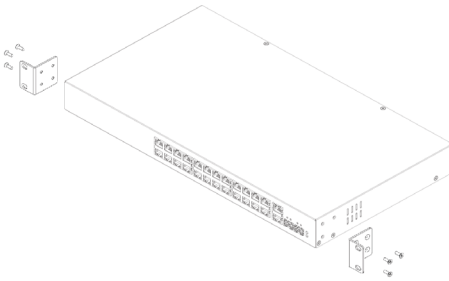

Braket to the product

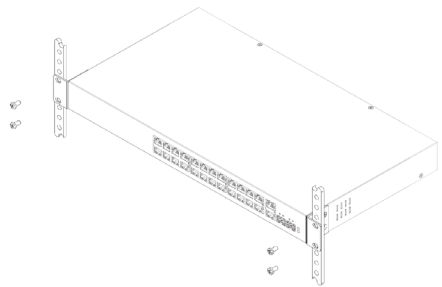

Product to the rack

Port Connection

DirectIP™ NVR Connection

Via UTP Cable

- 1 Connect the DirectIP™ NVR's **VIDEO IN/Ext.** port to the system's **RJ-45 uplink combo** port using a UTP cable.
 - 2 Check the **RJ-45 uplink combo** port SPD LED's status and verify that a normal connection has been established.
- If you connect the DirectIP™ NVR's **VIDEO IN/PoE** port to the system's **RJ-45 uplink** port, the network bandwidth may not be enough, and the NVR may not record video normally.
 - If the PoE switch is not connected to network connection at 1000Mbps, the network bandwidth may not be enough, and the NVR may not record video normally.

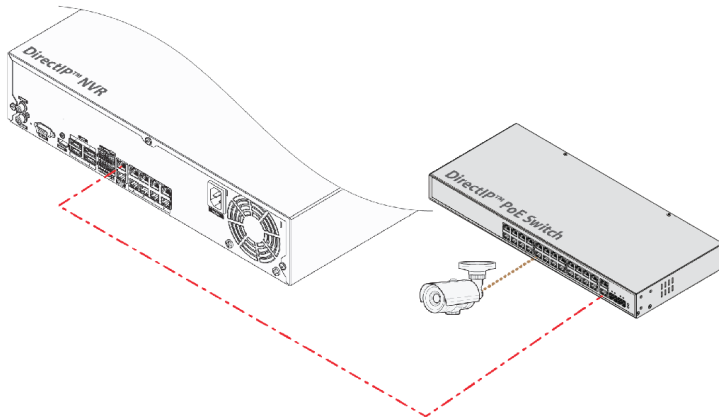

Remote Connection via an Optical Cable

- 1 Insert an SFP module into the DirectIP NVR or Switch's SFP port and connect one end of the optical cable to the module.
- 2 Insert an SFP module into the system's **SFP uplink port** and connect the other end of the optical cable to the module.
- 3 Check the **SFP uplink port** LED's status and verify that a normal connection has been established.

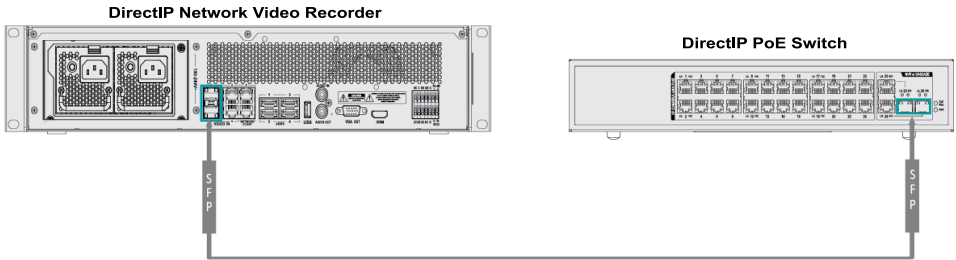

DirectIP™ Camera Connection

- 1 Connect the system's **RJ-45 service port** to the network camera's **RJ-45 port** using a UTP cable.
- 2 Check the **RJ-45 service port** LED's status and verify that a normal connection has been established.



PoE cameras connected to RJ-45 service ports can receive power through the UTP cable.

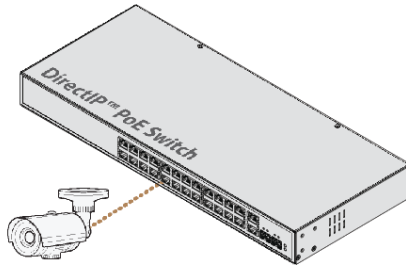

Cascading

- 1 Connect the **RJ-45 uplink combo ports** of system 1 and system 2 using a UTP cable.
- 2 Check the **RJ-45 uplink** port SPD LED's status and verify that a normal connection has been established between the two products.



If the PoE switch is not connected to network connection at 1000Mbps, the network bandwidth may not be enough, and the NVR may not record video normally.

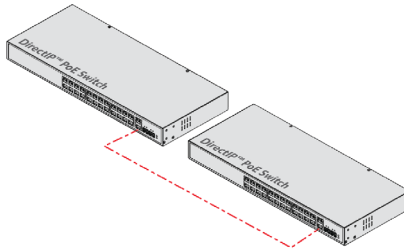

Remote Connection via an Optical Cable

- 1 Insert SFP modules into the **SFP uplink combo ports** of system 1 and system 2 and then connect the modules using a fiber optic cable.
 - 2 Check the **SFP uplink combo port** LEDs and verify that a normal connection has been established.
- If this product is not connected to network connection at 1000Mbps, the network bandwidth may not be enough, and the NVR may not record video normally.

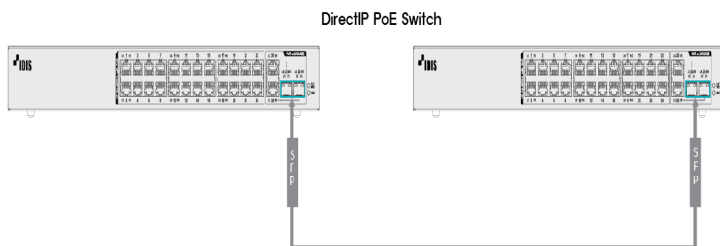

Port Connection Warnings and Tips



Keep the UTP cable length to less than 100m.



- Only use category 5 or higher UTP cables with RJ-45 connectors to connect to the system. The system's ports can automatically distinguish between MID and MDIX connectors, so there is no need to use a crossover cable when connecting to a different device's RJ-45 port.
- RJ-45 uplink combo port can be used as a service port, but does not support PoE.

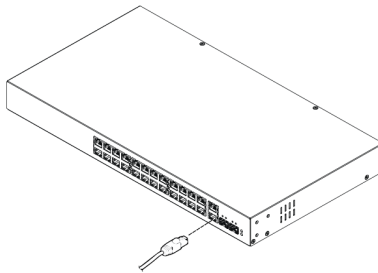

Part 3 - Miscellaneous

Supported SFP Transceiver Module List

The system's SFP ports support the following types of SFP modules:

Standard	Diameter (um)	Wavelength (nm)	Length	Mode	Connector	SFP Module
1000BASE-SX	50/125	850	500m	Multi	LC	Finisar FTL8519P3BNL
	62.5/125	850	300m	Multi	LC	
1000BASE-LX	9/125	1310	10Km	Single	LC	Finisar FTLF1318P3BTL



When installed on this product, some SFP Modules may not work properly. Recommend using the SFP Module listed in the compatibility table above.

Troubleshooting

Problem	Check
Power LED will not turn on.	<ul style="list-style-type: none"> ● Check the power cable. ● Check the power supply status to the outlet the power cable is connected to.
The system shuts down shortly after powering on.	<p>Check power connection components for electric leakage.</p> <ul style="list-style-type: none"> ● Check the outlet for electric leakage and current stability. ● Make sure the system's vents and ports are clean. ● If the problem persists, it could indicate a problem with the system's internals. Please contact the service center.
The system will not boot up.	<ul style="list-style-type: none"> ● Check the status of the power LED on the product front. ● Remove the power cable of the product and connect it again to restart the product and check the booting status.
The system is unable to recognize network interface.	<p>Check the interface cable and the cable's connection status.</p> <ul style="list-style-type: none"> ● Check each port's LED.

Specifications

Model	DH-2026PF	
CPU	Embedded CPU	
System Memory	32MB SDRAM, 16M Flash	
Switching Capacity	8.8Gbps	
Copper Service Port	24 RJ-45 Connectors (10/100BASE-T)	
Copper Uplink Combo Port	2 RJ-45 Combo Connectors (10/100/1000BASE-T)	
SFP Uplink Combo Port	2 SFP Connectors (1000BASE-X)	
Rated input	AC 100-240V, 50/60Hz	
Power Consumption	450W	
PSE Power	360W	
PoE-supported Standards	IEEE 802.3af-2003 / IEEE 802.3af-2009 Compliant	
PoE-Supported Network Camera Connection	Up to 24 IEEE 802.3af cameras or 12 IEEE 802.3at cameras	
Environmental Conditions	Operating Temperature	0°C - 40°C (32°F ~ 104°F)
	Operating Humidity	10 ~ 90%
	Storage Temperature	-30°C ~ 60°C (-2.2°F ~ 140°F)
Dimensions (W x H x D)	430mm x 44mm x 235mm (16.93" x 1.73" x 7.09")	
Weight (Main Unit)	2.62Kg (5.78 lbs.)	
Weight (Packaging)	3.51Kg (7.74 lbs.)	
Electrical Approvals	FCC, UL, CE, CB, KC	



- Dimensional width is exclusive of rack-mounting wings.
- These product specifications may change without prior notice.



IDIS Co., Ltd.

For more information, please visit at
www.idisglobal.com